

**SAMSUNG**

**GT-N8010**  
user manual



# Using this manual

Congratulations on your purchase of the Samsung mobile device. This powerful, “go anywhere” device, puts the best of the web and mobile computing at your fingertips in a lightweight, highly versatile platform that fits your active lifestyle. Built on the Google Android operating system, the Samsung mobile device gives you access to thousands of useful and entertaining applications to enrich your mobile web experience.

With integrated wireless access and a responsive touch screen, you can read books and newspapers on the go; stay up-to-date on the latest news, sports, and weather; manage your multimedia and business files; and browse the web for maps, business locations, and more.

## Read me first

- Please read all safety precautions and this manual carefully before using your device to ensure safe and proper use.
- The descriptions in this manual are based on the default settings of your device.
- Images and screenshots used in this user manual may differ in appearance from the actual product.
- Content in this user manual may differ from the product, or from software provided by service providers or carriers, and is subject to change without prior notice. Refer to [www.samsung.com](http://www.samsung.com) for the latest version of the user manual.

- Available features and additional services may vary by device, software, or service provider.
- Formatting and delivery of this user manual is based on Google Android operating systems and may vary depending on the user's operating system.
- Applications and their functions may vary by country, region, or hardware specifications. Samsung is not liable for performance issues caused by third-party applications.
- Samsung is not liable for performance issues or incompatibilities caused by edited registry settings or modified operating system software. Attempting to customise the operating system may cause your device or applications to work improperly.
- You may upgrade your mobile device's software by accessing [www.samsung.com](http://www.samsung.com).
- Software, sound sources, wallpapers, images, and other contents provided in this device are licenced for limited use between Samsung and their respective owners. Extracting and using these materials for commercial or other purposes is an infringement of copyright laws. Samsung is not liable for such copyright infringement by the user.
- Please keep this manual for future reference.

## Instructional icons

Before you start, familiarise yourself with the icons you will see in this manual:



**Warning**—situations that could cause injury to yourself or others



**Caution**—situations that could cause damage to your device or other equipment



**Note**—notes, usage tips, or additional information

- ▶ **Refer to**—pages with related information; for example: ▶ p.12 (represents “see page 12”)
- **Followed by**—the order of options or menus you must select to perform a step; for example: Open the application list and select **Settings** → **About device** (represents **Settings**, followed by **About device**)

## Copyright

Copyright © 2012 Samsung Electronics

This user manual is protected under international copyright laws.

No part of this user manual may be reproduced, distributed, translated, or transmitted in any form or by any means, electronic or mechanical, including photocopying, recording, or storing in any information storage and retrieval system, without the prior written permission of Samsung Electronics.



## Trademarks

- SAMSUNG and the SAMSUNG logo are registered trademarks of Samsung Electronics.
- The Android logo, Google™, Google Maps™, Google Mail™, YouTube™, Google Play™ Store, and Google Talk™ are trademarks of Google, Inc.
- Bluetooth® is a registered trademark of the Bluetooth SIG, Inc. worldwide.
- Wi-Fi®, Wi-Fi Protected Setup™, Wi-Fi Direct™, Wi-Fi CERTIFIED™, and the Wi-Fi logo are registered trademarks of the Wi-Fi Alliance.
- DivX®, DivX Certified® and associated logos are trademarks of Rovi Corporation or its subsidiaries and are used under licence.
- All other trademarks and copyrights are the property of their respective owners.



## **ABOUT DIVX VIDEO**

DivX® is a digital video format created by DivX, LLC, a subsidiary of Rovi Corporation. This is an official DivX Certified® device that plays DivX video. Visit [www.divx.com](http://www.divx.com) for more information and software tools to convert your files into DivX videos.

## **ABOUT DIVX VIDEO-ON-DEMAND**

This DivX Certified® device must be registered in order to play purchased DivX Video-on-Demand (VOD) movies. To obtain your registration code, locate the DivX VOD section in your device setup menu. Go to [vod.divx.com](http://vod.divx.com) for more information on how to complete your registration.

DivX Certified® to play DivX® video up to HD 720p, including premium content.

May play DivX® video up to HD 1080p.

# Contents

<b>Assembling .....</b>	<b>12</b>
Unpack .....	12
Charge the battery .....	13
Insert a memory card (optional) .....	15
<b>Getting started .....</b>	<b>18</b>
Turn your device on and off .....	18
Get to know your device .....	19
Use the S Pen and the touch screen .....	23
Get to know the Home screen .....	25
Access applications .....	31
Customise your device .....	32
Enter text .....	38
<b>Using special features .....</b>	<b>40</b>
Learn basic S Pen actions.....	40
Learn advanced S Pen actions.....	41
Replace the tip of S Pen.....	42
Learn motions .....	43
Use Handwriting mode.....	44
Use S Note.....	48
Use the quick note pad .....	56
Use S Planner .....	57
Learn Quick Command feature.....	60
S Pen Air View .....	61
Capture screen area .....	61

<b>Web .....</b>	<b>62</b>
Internet .....	62
Game Hub .....	67
Play Books .....	67
Play Store .....	67
YouTube .....	68
Video Hub .....	69
Maps .....	69
Local .....	72
Navigation .....	72
Samsung Apps .....	73
S Suggest .....	74
Google .....	74
Learning Hub .....	75
<b>Communication .....</b>	<b>76</b>
Google Mail .....	76
Email .....	78
Talk .....	80
ChatON .....	81
Messenger .....	82
Google+ .....	82
<b>Entertainment .....</b>	<b>83</b>
Music Player .....	83
Music Hub .....	86
Camera .....	86
Video Player .....	95
Gallery .....	99

Paper Artist .....	103
Video Editor .....	103
<b>Personal information .....</b>	<b>107</b>
Contacts .....	107
<b>Connectivity .....</b>	<b>110</b>
PC connections .....	110
Wi-Fi .....	112
Wi-Fi Direct .....	115
AllShare Cast .....	116
AllShare Play .....	117
Group Cast .....	120
Bluetooth .....	121
GPS .....	123
TV connections .....	124
VPN connections .....	126
<b>Tools .....</b>	<b>128</b>
Alarm .....	128
Calculator .....	129
Downloads .....	129
Dropbox .....	129
My Files .....	131
Polaris Office .....	133
PS Touch .....	135
Voice Search .....	135
S Voice .....	136
World Clock .....	136

<b>Settings .....</b>	<b>137</b>
Access the Settings menu .....	137
Wi-Fi .....	137
Bluetooth .....	137
Data usage .....	137
More settings .....	138
Blocking mode .....	139
Sound .....	139
Display .....	139
Storage .....	140
Power saving mode .....	141
Battery .....	141
Application manager .....	141
Location services .....	141
Lock screen .....	142
Security .....	143
Language and input .....	144
Cloud .....	146
Back up and reset .....	147
Add account .....	147
Motion .....	147
S Pen .....	148
Accessory .....	148
Date and time .....	149
Accessibility .....	149
Developer options .....	150
About device .....	152

**Troubleshooting ..... 153**  
**Index ..... 157**

# Assembling

## Unpack

Check your product box for the following items:

- Mobile device
- Quick start guide

 Use only Samsung-approved software. Pirated or illegal software may cause damage or malfunctions that are not covered by your manufacturer's warranty.

- 
- The items supplied with your device and available accessories may vary depending on your region or service provider.
  - You can purchase additional accessories from your local Samsung dealer.
  - The supplied accessories perform best for your device.
  - Accessories other than the supplied ones may not be compatible with your device.



## Charge the battery

Your device has a built-in battery. Before using the device for the first time or when the battery has been unused for an extended period, you must charge the battery.



Use only Samsung-approved chargers. Unauthorised chargers can cause batteries to explode or damage your device.



- Charge the battery only with a charger. You cannot charge the battery with the USB cable.
- When your battery is low, the device will emit a warning tone and display a low battery message. The battery icon  will also be empty. If the battery level becomes too low, the device will automatically power off. Recharge your battery to continue using your device.
- If the battery is completely discharged, you cannot turn on the device, even with the USB power adapter connected. Allow a depleted battery to charge for a few minutes before you try to turn on the device.

*I* Connect the USB cable to the USB power adapter, and then plug the end of the USB cable into the multifunction jack.



The shape of the USB power adapter may differ depending on your region.

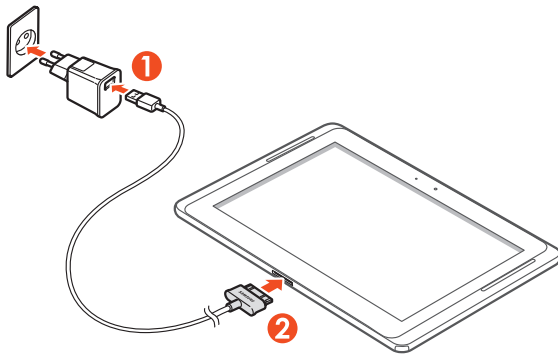

**!** Connecting the USB cable improperly may cause serious damage to the device or USB power adapter. Any damage caused by misuse is not covered by the warranty.

2 Plug the USB power adapter into a power outlet.



- You can use the device while it is charging, but it may take longer to fully charge the battery.
- While the device is charging, the touch screen may not function due to an unstable power supply. If this happens, unplug the USB power adapter from the power outlet or unplug the USB cable from the device.
- While charging, the device may heat up. This is normal and should not affect your device's lifespan or performance.
- If your device is not charging properly, bring your device and the charger to a Samsung Service Centre.

3 When the battery is fully charged, first unplug the USB power adapter and USB cable from the device, and then from the power outlet.



To save energy, unplug the USB power adapter when not in use. The USB power adapter does not have a power switch, so you must unplug the USB power adapter from the electrical socket when not in use to avoid wasting power. The device should remain close to the electrical socket while charging.

## Insert a memory card (optional)

Your device accepts memory cards with maximum capacities of 64 GB. Depending on the memory card manufacturer and type, some memory cards may not be compatible with your device.



Samsung uses approved industry standards for memory cards, but some brands may not be fully compatible with your device. Using an incompatible memory card may damage your device or the memory card and can corrupt data stored on the card.



- Your device supports only the FAT file structure for memory cards. If you insert a card formatted with a different file structure, your device will ask you to reformat the memory card.
- Frequent writing and erasing of data will shorten the lifespan of memory cards.
- When you insert a memory card in your device, the file directory of the memory card will appear in the extSdCard folder under the internal memory.

- 1 Open the cover of the memory card slot.
- 2 Insert a memory card with the gold-coloured contacts facing down.

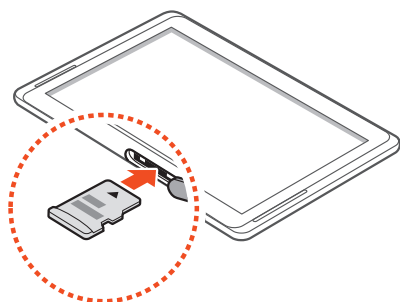

- 3 Push the memory card in the memory card slot until it locks in place.
- 4 Close the memory card cover.

## ▶ Remove the memory card

Before removing a memory card, first unmount it for safe removal.

- 1 Open the application list and select **Settings** → **Storage** → **Unmount SD card** → **OK**.
- 2 Open the memory card cover.
- 3 Push the memory card gently until it disengages from the device.
- 4 Remove the memory card.
- 5 Close the memory card cover.

 Do not remove a memory card while the device is transferring or accessing information, as this could result in loss of data or damage to the memory card or device.

## › Format the memory card

Formatting your memory card on a PC may cause incompatibilities with your device. Format the memory card only on the device.

Open the application list and select **Settings** → **Storage** → **Format SD card** → **Format SD card** → **Erase everything**.



Before formatting the memory card, remember to make backup copies of all important data stored on your device. The manufacturer's warranty does not cover loss of data resulting from user actions.

# Getting started

## Turn your device on and off

To turn on your device, press and hold the Power key. If you turn on your device for the first time, follow the on-screen instructions to set up your device.

To turn off your device, press and hold the Power key and select **Power off** → **OK**.



- Follow all posted warnings and directions from authorised personnel in areas where the use of wireless devices is restricted, such as aeroplanes and hospitals.
- To use your device's non-network services only, switch to Flight mode.

## › Switch to Flight mode

In Flight mode, you can disable all wireless connections and use non-network services in areas where wireless devices are prohibited, such as aeroplanes and hospitals.

To activate or deactivate Flight mode, go to **Settings** → **More settings** and then check the check box next to **Flight mode** → **OK**.

# Get to know your device

## > Device layout

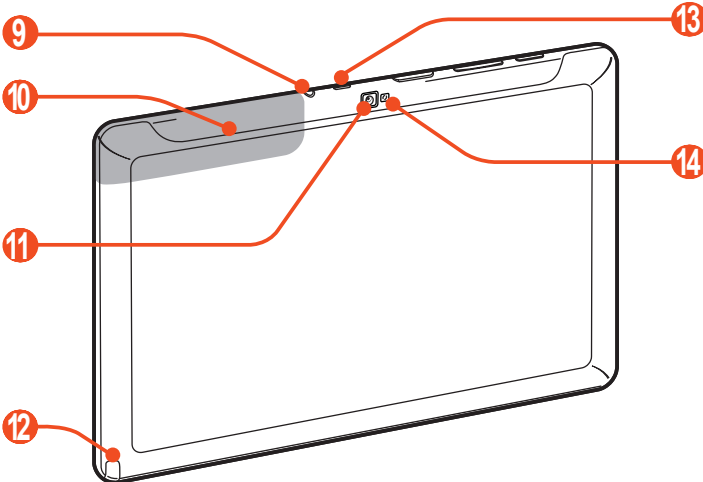
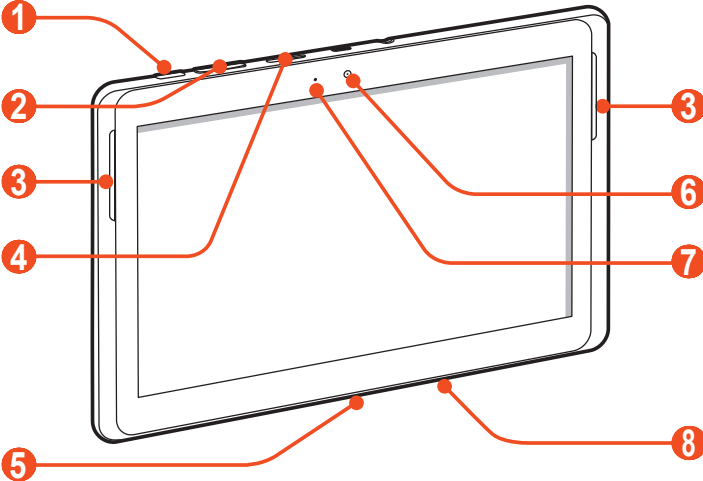



Number	Function
1	Power/Reset/Lock key
2	Volume key
3	Speaker
4	Memory card slot
5	Multifunction jack
6	Front camera lens
7	Ambient light sensor
8	Mouthpiece
9	Headset jack <sup>1</sup>
10	Internal antenna
11	Rear camera lens
12	S Pen slot
13	IrLED
14	Flashbulb

---

1. Connecting a headset to your device improperly can damage the headset jack or the headset.









## › Keys











Key	Function
 Power/ Reset <sup>2</sup> / Lock	Turn on the device (press and hold); Access the device options (press and hold); Lock the touch screen; Reset the device (press and hold for 8-10 seconds.)
 Volume	Adjust the device's volume.

## › Indicator icons

 Icons shown on the bottom of the screen may vary depending on your region or service provider.

Icon	Definition
	Open Wi-Fi APs available
	Wi-Fi AP connected
	Bluetooth activated
	GPS activated
	Uploading data
	Downloading data

2. If your device has fatal errors or hang-ups, or freezes, you may need to reset the device to regain functionality.

Icon	Definition
	Connected to PC
	New email message
	New Google Mail
	Alarm activated
	Event notification
	Flight mode activated
	Music playback in progress
	Error occurred or caution required
	Smart stay activated
	S Pen removed
	Battery power level <sup>3</sup>
10:00 AM	Current time

3. If you use a charger that is not approved by Samsung, this indicator will not appear.

## Use the S Pen and the touch screen

Your device's touch screen lets you easily select items or perform functions. Learn basic actions for using the touch screen.



- Do not press the touch screen with your fingertips, or use sharp tools on the touch screen. Doing so may damage the touch screen or cause it to malfunction.
- Do not allow the touch screen to come into contact with other electrical devices. Electrostatic discharges can cause the touch screen to malfunction.
- Do not allow the touch screen to come into contact with water. The touch screen may malfunction in humid conditions or when exposed to water.
- Leaving the touch screen idle for extended periods may result in afterimages (screen burn-in) or ghosting. Turn off the touch screen when you do not use the device.
- Do not bend the S Pen.
- Do not use the S Pen near by a source of magnetic interference. It may cause the S Pen to malfunction or freeze.



- For optimal use of the touch screen, remove the screen protection film before using your device.
- You can purchase a replacement S Pen from your local Samsung dealer.
- If your S Pen is not working properly, replace the tip of the S pen or take it to a Samsung Service Centre.
- For best results, keep the S Pen mostly perpendicular to the touch screen and avoid using it at sharp angles.

Control your touch screen with the following actions:

- Tap: Touch once with your finger or the supplied S Pen to select or launch a menu, option, or application.
- Tap and hold: Tap an item and hold it for more than 2 seconds to open a list of options.
- Drag: Tap and drag your finger up, down, left, or right to move to items on lists.
- Drag and drop: Tap and hold your finger on an item, and then drag your finger to move the item.
- Double-tap: Tap twice quickly with your finger to zoom in or out while viewing photos or web pages.

## › Rotate the touch screen

Your device has a built-in motion sensor that detects its orientation. If you rotate the device, the interface will automatically rotate according to the orientation.

To set the interface to keep the orientation, select the right side of the system bar, and then select **Screen rotation** on the notifications panel.

## › Lock or unlock the touch screen

When you do not use the device for a specified period, your device turns off the touch screen and automatically locks the touch screen to prevent any unwanted device operations. To manually lock the touch screen, press the Power key.

To unlock, turn on the screen by pressing the Power key, tap anywhere on the screen, and then flick your finger in any direction.



You can activate the screen lock feature to prevent others from using or accessing your personal data and information saved in your device. ► p. 35

## Get to know the Home screen

When the device is in Idle mode, you will see the Home screen. From the Home screen, you can view indicator icons, widgets, shortcuts to applications, and other items. Scroll left or right to a panel of the Home screen.

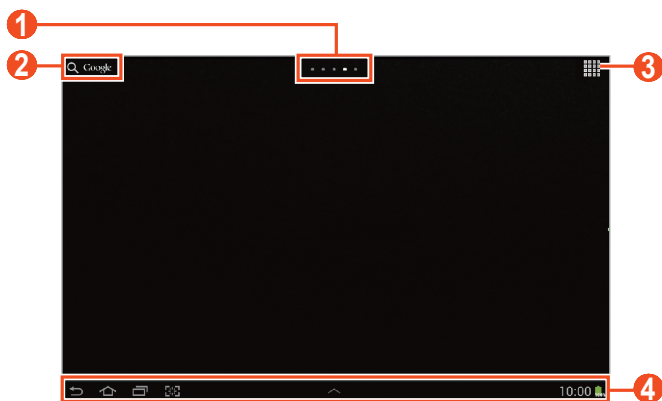

 The above screen may differ depending on your region or service provider.

Number	Function
1	Select a dot at the top of the screen to move directly to the corresponding screen.
2	Search for applications and files in your device and specific data on the web with the Google Search widget.
3	Access the application list.
4	System bar (See the following section.)

## System bar

From the system bar, you can quickly navigate screens, access applications, view system information, and more.

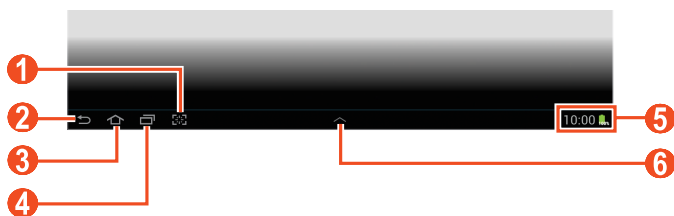

Number	Function
1	Capture the current screen; Capture the current screen and open the drawing pad (tap and hold). This can be changed to another feature. ► p. 140
2	Return to the previous screen.
3	Return to the Home screen; Access the Google search widget or Google Now (tap and hold).
4	Open the list of recent application.
5	Display indicator icons and your device's current status; Open the notifications panel.
6	Open Multi Window panel.

## ► Add an application shortcut on the Home screen

- 1 Open the application list and tap and hold an application icon.
- 2 Move the icon to the location you want or move it to another panel of the Home screen.

## › Add a widget on the Home screen

Widgets are small applications that provide convenient functions and information on your Home screen.



The widgets available may vary depending on your region or service provider.

- 1 Open the application list and select **Widgets** to open the widget panel.
- 2 Scroll left or right on the widget panel.
- 3 Tap and hold a widget to add it to the Home Screen.

## › Move an item on the Home screen



- 1 Tap and hold an item to move until the Home screen grid appears.
- 2 Drag the item to the location you want.

## › Remove an item on the Home screen

- 1 Tap and hold an item to remove.  
The rubbish bin appears at the top of the Home screen.
- 2 Drag the item to the rubbish bin.
- 3 When the rubbish bin turns red, release the item.





## › Add or remove a panel from the Home screen

You can add or remove Home screen panels to organise widgets.

- 1 On the Home screen, place two fingers on the screen and pinch them together to switch to Edit mode.
- 2 Add, remove, or reorganise panels:
  - To add a new panel, select .
  - To remove a panel, tap and hold the panel's thumbnail image, and then drag it to the rubbish bin.
  - To set a panel for the default Home screen, select .
  - To change the order of panels, tap and hold the panel's thumbnail image, and then drag it to a new location.
- 3 Select  to return to the previous screen.

## › Launch Multi Window applications

Applications launched from the Multi Window panel appear in smaller windows, which are movable and can be increased and decreased.

- 1 Select  on the system bar to open the Multi Window panel.
- 2 Select an application to launch it.
  - To move the application to another location, tap and hold the application's title and drag it to a new location.
  - To maximise the window to fit the screen, select .
  - To make the application stay always on the top, select .
  - To close the application, select  or .



- To display two different Multi Window applications side by side in full screen, select **Dual view**. You can switch the positions of the two applications by tapping and holding an application's title bar, and then dragging it on the other application.
- To arrange launched Multi Window applications in overlaid windows, select **Cascade view**.

## Configure Multi Window applications

1 Select  on the system bar to open the Multi Window panel.

2 Select **Edit**.

The upper panel displays the list of applications that can launch as Multi Window applications, while the lower panel displays the list of applications that are added to the Multi Window panel.

- To add an application to the Multi Window panel, select an item from the upper panel.
- To remove an application from the Multi Window panel, select an item from the lower panel.

3 When you are finished, select **Done**.

## › Use the notifications panel

From the Home screen or while using an application, select the right side of the system bar, and then select an option on the notifications panel.



You can view the device's current status and use the following options:

- **Wi-Fi:** Activate or deactivate the Wi-Fi feature.
- **GPS:** Activate or deactivate the GPS feature.
- **Sound:** Activate or deactivate Silent mode. You can vibrate or mute your device in Silent mode.
- **Screen rotation:** Activate or deactivate the auto rotation.
- **Bluetooth:** Activate or deactivate the Bluetooth feature.
- **Blocking mode:** Activate or deactivate Blocking mode. In Blocking mode, your device will block all notifications.
- **Power saving:** Activate or deactivate Power saving mode.
- **AllShare Cast:** Activate or deactivate AllShare Cast feature.
- **Sync:** Activate or deactivate auto-syncing of applications.



Available options may vary depending on your region or service provider.

## Access applications

- 1 From the Home screen, select  to access the application list.
- 2 Scroll left or right to another screen.  
You can also select one of the dots at the bottom of the screen to move directly to the corresponding screen.
- 3 Select an application.  
To view the widgets panel, select **Widgets**.
- 4 Select  to return to the previous screen; Select  to return to the Home screen.

### › Access recent applications

- 1 Select  to view the applications you have accessed recently.
- 2 Select an application.

### › Use the task manager

Your device is a multitasking device. It can run more than one application at the same time. However, multitasking may cause hang-ups, freezing, memory problems, or additional power consumption. To avoid these problems, end unnecessary programs using the task manager.

- 1 Select  → **Task manager** → **Active applications**.
- 2 To close an application, select **End**.  
To close all active applications, select **End all**.

## Customise your device

Get more from your device by customising it to match your preferences.

### › Change the language of the display

- 1 Open the application list and select **Settings** → **Language and input** → **Language**.
- 2 Select a language you want.

### › Set the current time and date

- 1 Open the application list and select **Settings** → **Date and time**.
- 2 Select your time zone, set the time and date, and change other options.

### › Turn the touch tone on or off

Open the application list and select **Settings** → **Sound** → **Touch sounds**.

### › Adjust the device's volume

- 1 Press the Volume key up or down.
- 2 Select  and drag the sliders to adjust the volume level for each sounds.

## › Switch to Silent mode

To mute or unmute your device, do one of the following:

- Open the notifications panel at the right side of the system bar and select **Sound**.
- Press and hold the Power key, and then select .

## › Select a wallpaper for the Home screen

1 Tap and hold anywhere on the Home Screen.

2 Select **Set wallpaper** → **Home screen**.

- **Gallery**: Photos you took or images downloaded from the Internet.
- **Live wallpapers**: Animated images included with the device.
- **Wallpapers**: Wallpaper images included with the device.

3 Select an item.

4 Select **Set wallpaper**.

If you selected an item from **Gallery**, move or resize the blue frame by dragging it, and then select **Done**.



Samsung is not responsible for any use of default images or wallpapers provided on your device.

## › Adjust the brightness of the display

Your device includes a light sensor, which can detect the level of ambient light and adjust the brightness of the display automatically. You can also manually set the brightness of the display.



The brightness level of the display will affect how quickly the device consumes battery power.

### Set your device to adjust the brightness automatically

- 1 Open the application list and select **Settings** → **Display** → **Brightness**.
- 2 Select the check box next to **Automatic brightness**.
- 3 Select **OK**.  
The device will increase the brightness in bright surroundings and decrease the brightness in dim surroundings automatically.

### Adjust the brightness manually

- 1 Open the application list and select **Settings** → **Display** → **Brightness**.
- 2 Clear the check box next to **Automatic brightness**.
- 3 Drag the slider to the left or right.
- 4 Select **OK**.

## › Set a screen lock

You can lock your device by activating the screen lock feature.



- Once you set a screen lock, your device will require an unlock code each time you turn it on or unlock the touch screen.
- If you forget your PIN or password, bring your device to a Samsung Service Centre to reset it.
- Samsung is not responsible for any loss of security codes or private information or other damages caused by illegal software.

## Set a face detection unlock

- 1 Open the application list and select **Settings** → **Lock screen** → **Screen lock** → **Face unlock**.
- 2 Read the warning message, and then select **Next**.
- 3 Select **Set it up** → **Continue**.
- 4 Adjust the device to fit your face inside the figure.
- 5 When your face is captured correctly, select **Continue**.
- 6 Complete the setup of the secondary unlock PIN or pattern.

## Set a face and voice recognition unlock

- 1 Open the application list and select **Settings** → **Lock screen** → **Screen lock** → **Face and voice**.
- 2 Select **Next** → **Set it up** → **Continue**.
- 3 Adjust the device to fit your face inside the figure.
- 4 When your face is captured correctly, select **Continue**.
- 5 Select .
- 6 Say a word or phrase to use as an unlock command 4 times.
- 7 Select **Done**.  
For higher security, select **Adapt Voice**.
- 8 Complete the setup of the secondary unlock PIN or pattern.

## Set an unlock signature

- 1 Open the application list and select **Settings** → **Lock screen** → **Screen lock** → **Signature**.
- 2 Select **Set it up**.
- 3 Draw a signature and select **Continue**.  
Repeat this step 3 times to set the signature unlock.
- 4 Complete the setup of the secondary unlock PIN or pattern.



## Set an unlock pattern

- 1 Open the application list and select **Settings** → **Lock screen** → **Screen lock** → **Pattern**.
  - 2 See the on-screen instructions and example patterns and select **Next**.
  - 3 Draw a pattern by dragging your finger to connect at least 4 dots and select **Continue**.
  - 4 Draw the pattern again to confirm and select **Confirm**.
  - 5 Complete the setup of the backup PIN.
-  If you forget your unlock pattern, you can deactivate the screen lock feature with a backup PIN.

## Set an unlock PIN

- 1 Open the application list and select **Settings** → **Lock screen** → **Screen lock** → **PIN**.
- 2 Enter a new PIN (numeric) and select **Continue**.
- 3 Enter the PIN again and select **OK**.

## Set an unlock password

- 1 Open the application list and select **Settings** → **Lock screen** → **Screen lock** → **Password**.
- 2 Enter a new password (alphanumeric) and select **Continue**.
- 3 Enter the password again and select **OK**.

## Enter text

You can enter text by selecting characters on the virtual keypad, inputting handwriting on the screen, or speaking words into the microphone.

 You cannot enter text in some languages. To enter text, you should change the writing language to one of the supported languages.

### › Change the keyboard type

You can change the keyboard type. Select  on the system bar and select a keyboard type.

You can also enter text with your voice. Select  and a voice input option, according to the language you want to use.

### › Enter text using the Samsung keypad

Enter text by selecting alphanumeric keys and you can use the following keys:

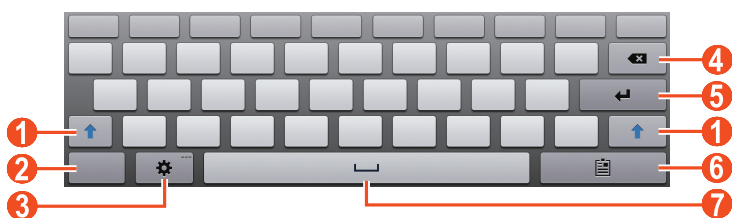

 The above screen may differ depending on your region or service provider.

Number	Function
1	Change case.
2	Switch between Number/Symbol mode and ABC mode.



Number	Function
3	Access the keypad settings. Tap and hold  to switch to Handwriting mode, enter text by voice.
4	Clear your input.
5	Start a new line.
6	Attach an item.
7	Insert a space.



When Predictive text (XT9) mode is activated, you can use continuous input, which allows you to enter text by sweeping on the keypad. ► p. 144

## › Copy and paste text

While you are entering text, you can use the copy and paste feature to use text in other applications.

- 1 Tap and hold a word.
- 2 Drag  or  to select the text you want.
- 3 Select **Copy** to copy, or **Cut** to cut the text onto the clipboard.
- 4 In another application, tap and hold the text input field.
- 5 Select **Paste** to insert the text from the clipboard into the text input field.

# Using special features

Your device can be used as a powerful notepad, thanks to multiple features that help you input text, capture drawings, and use motion controls or voice commands.

## Learn basic S Pen actions

Your device is supplied with a specialised S Pen. With the S Pen, you can perform the following actions:

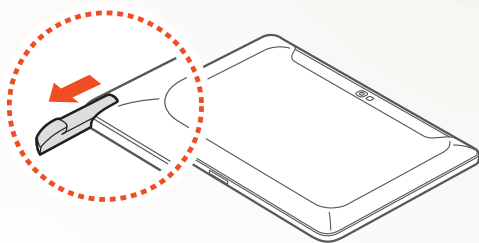

- Tap: Tap an item or area on the screen to select an item, open a menu, or launch an application.
- Tap and hold: Tap and hold the S Pen on an item for more than two seconds.
- Double-tap: Quickly tap an item or area on the screen twice.
- Flick: Tap an area on the screen, and then slowly drag the S Pen up, down, left, or right to move through lists or screens.
- Draw: Draw a line or shape on the drawing pad.
- Write: Write text on the handwriting panel.

## Learn advanced S Pen actions

With the S Pen, you can also perform the following advanced actions.



### Back

While pressing the S Pen button, draw < to return to the previous screen.

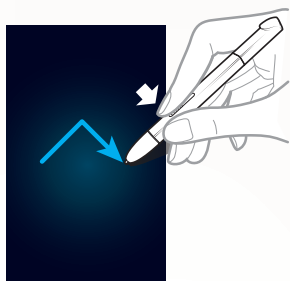

### Menu

While pressing the S Pen button, draw ^ to open a list of options available on the current screen.



### Screen capture

While pressing the S Pen button, tap and hold the screen to capture a screenshot.

After capturing a screenshot, you can draw on it, write on it, or crop it. The edited image will be saved in **My Files** → **sdcard0** → **Pictures** → **Screenshots**.



### Quick note

While pressing the S Pen button, double-tap the screen to launch the Quick note function.

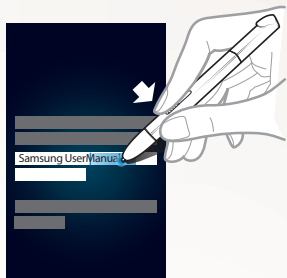

## Text selection

While pressing the S Pen button, drag the S Pen to the left or right on the text to select.



## Quick command

While pressing the S Pen button, drag the S Pen up to launch the Quick Command feature.

On the Quick Command screen, draw a gesture command to launch the assigned application or feature.

► p. 60

## Replace the tip of S Pen

If the tip is worn down or seems the S Pen is not working properly, replace the tip as new one.

 If the S Pen is not working properly after replacing the tip, make sure the tip is fully inserted until it reaches the end.

- 1 Grab the tip with the tip extractor tool, and then pull it out.
- 2 Insert a new tip into the S Pen where you just removed until it reaches the end.

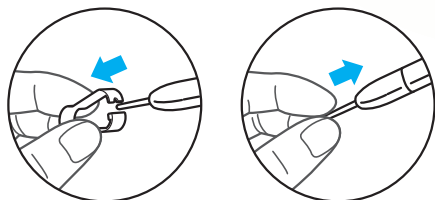

## Learn motions

Built-in motion recognition provides you with enhanced controls. You can perform actions by moving your device or performing gestures with your hands.

To use some of these functions, you must first activate the motion recognition feature. Open the application list, select **Settings** → **Motion**, and then drag the slider to the right of the top right of the screen.

### › Tilt

While holding the device with two hands, tap and hold two points on the screen, and then tilt the device back and forth to zoom in or out.



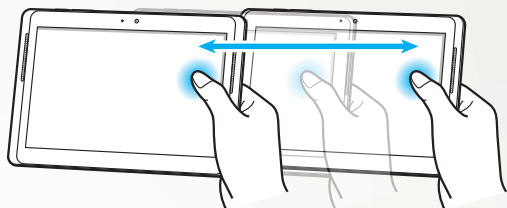

## › Pan

Tap and hold an item on the screen, and then pan the device to the left or right to move the item to another page on the home screen or application list. When an image is zoomed in, slide the device in any direction to scroll through the image.



## Use Handwriting mode

From the Samsung keypad, you can switch to Handwriting mode to enter text more easily. To switch to Handwriting mode, tap and hold , and then select  without lifting from screen.



Write your text on the handwriting panel.

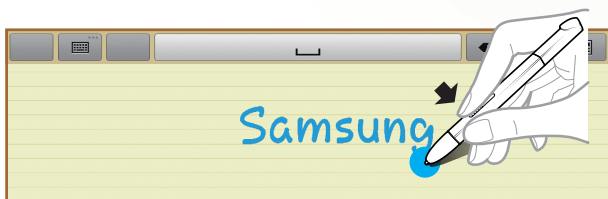

To switch to the Samsung keypad, select .



## › Handwriting Tutorial

- When you have written one character, write the next one. Write each letter to the right of the previous character. If you draw a stroke on top of a previous character, it may be recognised as a new character.
  - E.g. Not recognised



- Write characters upright (do not slant).
  - E.g. Recognised

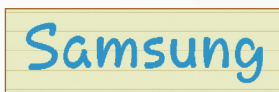

- E.g. Not recognised

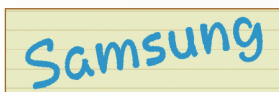

- Do not write characters on top of one another.
  - E.g. Recognised

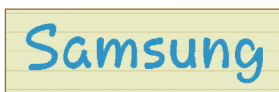

- E.g. Not recognised

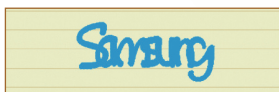

- Most of the languages can recognise not only individual characters but characters written together that make up words. (This is referred to as supporting words and phrases.) The languages that do and do not support words and phrase should be listed in this guide. (All languages which support Handwriting SIP should support words and phrases.)

- Languages that support words and phrases: English UK, English US, Čeština, Български, Dansk, Deutsch, Ελληνικά, Español, Eesti, Suomi, Français, Hrvatski, Magyar, íslenska, Italiano, Қазақ, 한국어, Lietuvių, Latviešu, Norsk, Nederlands, Polski, Português, Română, Русский, Slovenčina, Slovenščina, Srpski, Svenska, Türkçe, Українська
- Supporting recognition of individual characters

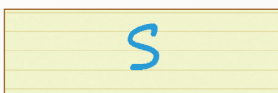

- Supporting recognition of words and phrases

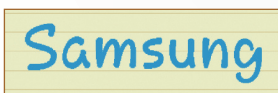

- In some languages, cursive writing can be recognised. (Cursive writing recognition)
  - For languages in which cursive writing is recognised, connected character writing should also be recognised.
  - For languages in which cursive writing is not recognised, characters should be written separately.
  - Languages that do and do not support cursive writing should be listed in this guide.

- Languages that support cursive writing: English UK, English US, Deutsch, Español, Français, Italiano, Nederlands, Português
- Languages that do not support cursive writing: Čeština, Български, Ελληνικά, Eesti, Hrvatski, Magyar, íslenska, Қазақ, 한국어, Lietuvių, Latviešu, Polski, Română, Русский, Slovenčina, Slovenščina, Srpski, Türkçe, Українська, Dansk, Suomi, Norsk, Svenska
- E.g. A language that supports cursive writing: English

Samsung

- E.g. A language that does not support cursive writing: 한국어



- When writing more than one line, make sure you leave enough space.
  - E.g. Recognised

Samsung  
Galaxy Note

- E.g. Not recognised

Samsung  
Galaxy Note

## Use S Note

With S Note, you can create notes by inserting various multimedia contents into notes and add a note shortcut to the home screen.

S Note provides various templates to help you create notes easily.

- **Note/Idea note:** You can create a simple note from an empty page.
- **Meeting note:** You can create a record of meetings, conferences, or lectures.
- **Magazine:** You can create a multimedia note by inserting multimedia files.
- **Diary:** You can create a photo diary.
- **Recipe:** You can create your own recipes.
- **Travel:** You can create travel essays.
- **Memo:** You can create memos.
- **Landscape note:** You can create doodles and drawings.

### › Create a note

- 1 Open the application list and select **S Note**.
- 2 Select **+** → a template.
- 3 Enter text or draw a sketch.

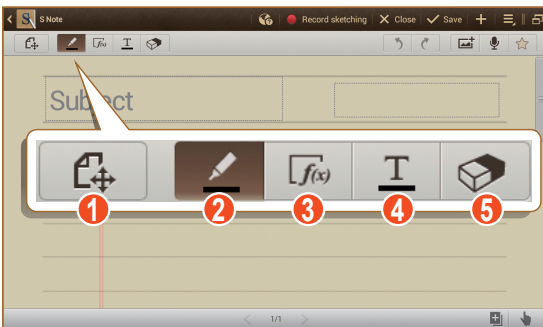

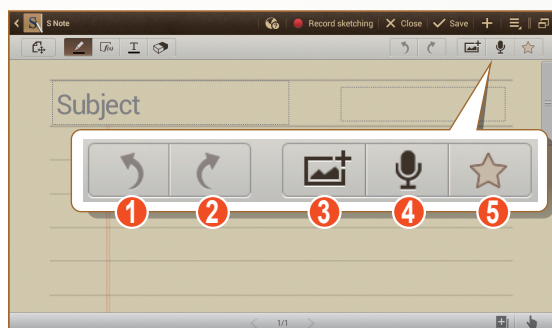

Number	Function
1	Switch between View and Edit modes.
2	Draw a sketch; Change the pen settings (double-tap). ► p. 50
3	Use productivity tools. ► p. 51
4	Enter text with the keyboard; Change the text settings (double-tap). ► p. 50
5	Erase your sketch or handwritings; Change the eraser thickness or clear your input (double-tap).

- 4 Add a photo or sound clip.  
You can record the sketching and tracing process.



Number	Function
1	Undo your last action.
2	Redo your last action.
3	Add a multimedia file, such as text or a photo.
4	Add a sound clip by recording voices or other sounds.
5	Mark the note as important.

- To add a page, select .
- To draw only with the S Pen, select .
- To zoom in, place two fingers on the screen and spread them apart. To zoom out, move your fingers closer together. When zoomed in, drag with two fingers to scroll through the screen.

5 When you are finished, select **Save**.

## › Change the pen or text attributes

While creating a note, you can change following attributes:

- To change the pen type, line thickness, or pen colour, double-tap .

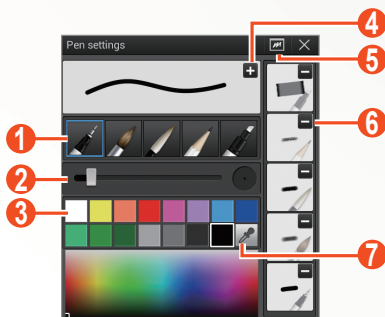

Number	Function
1	Change the pen type.
2	Change the line thickness.
3	Change the pen colour.
4	Save the current settings as a pen profile.
5	Open a small window to predraw the pen setting.
6	Delete the preset pen profile.
7	Add a new colour with the Color Picker.

- To change the text attributes, double-tap **T**.

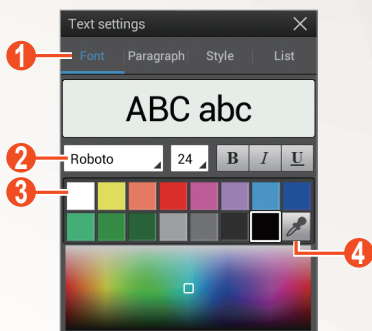

Number	Function
1	Select an option.
2	View or change the current attributes.
3	Change the text colour.
4	Add a new colour with the Color Picker.

## › Use productivity tools

1 Open the application list and select **S Note**.

2 Select **+** → a template.

3 Double-tap **f(x)** and select a tool.

- **Formula match:** Convert a handwritten formula to a well-organised formula.
- **Shape match:** Convert shapes you have drawn.
- **Handwriting-to-text:** Convert a handwritten note.



- When you tap and hold **f(x)**, the tool panel will appear and you can switch between tools easily.
- Select **🔍** to search for information about the handwritten keyword on a preset webpage.

## › Tutorial for handwritten formulas and figures

- Write a formula on a single line. If you write a long formula or a formula on more than one line, the device will convert the formula incorrectly.

$$y = t + e^t - \int_0^t y(\tau) \cosh(t - \tau) d\tau$$

↓

$$y = t + e^t - \int_0^t y(\tau) \cosh(t - T_{dT})$$

$$\begin{array}{l} 2x + 3y = 1 \\ 5x + y = 0 \end{array} \quad \Rightarrow \quad \begin{array}{l} ?x+3 \\ bx+y \end{array} \frac{y = 1}{-0}$$

- Unclosed parenthesis or missing figure in the square root will temporarily result in incorrect formula conversion. The formula will be complete when you finish writing the formula.

$$\sum_{x=0}^{100} (x - \frac{3}{2}) \quad \Rightarrow \quad \sum_{x=0}^{100} cx - \frac{3}{2} \quad (X)$$

---

$$\sum_{x=0}^{100} (x - \frac{3}{2}) \quad \Rightarrow \quad \sum_{x=0}^{100} \left( x - \frac{3}{2} \right) \quad (O)$$

$$\sqrt{\quad} \quad \Rightarrow \quad r \quad (X) \quad \sqrt{x} \quad \Rightarrow \quad \sqrt{x} \quad (O)$$



- When you draw an arrow, draw the body of the arrow first.



- When you draw the head of an arrow, draw it in one stroke.

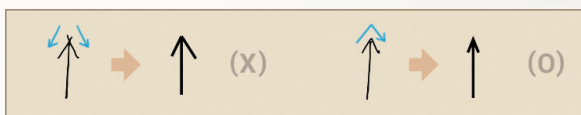









## › View notes





- 1 Open the application list and select **S Note**.
- 2 Select  to search for a note (if necessary).
- 3 Select a note.

While viewing the note, use the following options:

- To zoom in, place two fingers on the screen and spread them apart. To zoom out, move your fingers closer together.
- To move to other pages of the note, select the arrow at the bottom of the screen, scroll left or right, and then select a page.
- To see other parts of the zoomed-in note, move the red frame on the preview panel shown on the bottom left of the screen.
- To switch to Multi Window mode, select .

- To switch to Edit mode, select  or tap the screen.
- To send the note to others, select  → **Share via**.
- To export the note, select  → **Export**. Your note will be exported as an image file or a PDF file to **My Files** → **sdcard0** → **S Note Export**.
- To manage the note with multiple pages, select  → **Edit pages**.
- To save the note as an event, select  → **Create event**. This feature may be unavailable depending on the selected template.
- To add a shortcut of the note to the home screen, select  → **Set as shortcut**.
- To print the note using a Wi-Fi or USB connection, select  → **Print**. Your device is compatible only with some Samsung printers.
- To save the note for other name, select  → **Save as**.
- To set the note as your wallpaper or a contact image, select  → **Set as**.

## › Edit notes

- 1 Open the application list and select **S Note**.
- 2 Select a note.  
To add or change the note cover, tap and hold a note and select **Edit cover**.
- 3 Select  or tap the screen to switch to the Edit mode.
- 4 Edit the note with the icons on the screen.
  - To change the background image of the note, select  → **Change background**.
  - To delete the note, select  → **Delete**.
  - To add a tag, select  → **Add tag**.
- 5 Select **Save**.



## › Synchronise notes

You can synchronise your notes with the web server.

- 1 Open the application list and select **S Note**.
- 2 Select  → **Sync** → an option.
- 3 Select notes to sync, and then select **Sync**.  
To synchronise all notes, select **Sync all**.
- 4 Enter your email address and password, and then select **Login**.
- 5 Select **Sync now**.

## › Manage notes with folders

### Create a folder

- 1 Open the application list and select **S Note**.
- 2 Select  → **Create folder**.
- 3 Enter a name and select **OK**.
- 4 Select the new folder.
  - To create a note, select  → a template.
  - To create sub-folders, select  → **Create folder**.

### Copy or move notes

- 1 Open the application list and select **S Note**.
- 2 Select a folder (if necessary).
- 3 Select  → **Copy** or **Move**.
- 4 Select notes → **Copy** or **Move**.
- 5 Move to a new location.
- 6 Select **Copy here** or **Move here**.

## Use the quick note pad

From any screen, you can create a quick note of text and sketches.

- 1 While pressing the S Pen button, double-tap the screen to open the quick note pad.
- 2 Enter text or draw a sketch.

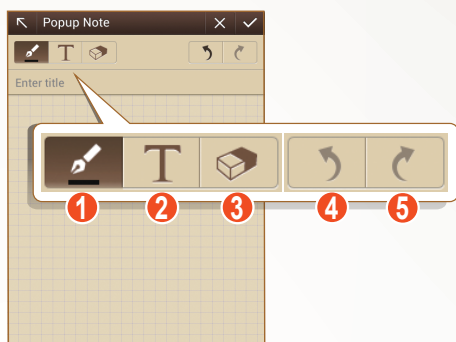

Number	Function
1	Draw a sketch; Change the pen settings, such as the pen type, line thickness, or pen colour (double-tap).
2	Enter text with the keyboard.
3	Erase your sketch or handwritings; Change the eraser thickness or clear your input (double-tap).
4	Undo your last action.
5	Redo your last action.

- 3 When you are finished, select .

## Use S Planner

Your device provides you with a powerful planner to help you organise your schedules and tasks more conveniently and effectively. You can create and view events, add items, and change view modes.

To launch S Planner, open the application list and select **S Planner**.





Number	Function
1	Select today's date.
2	Set which calendars to display.

### › Create an event or task

 The tasks and notes you create cannot be synchronised with Google Calendar™.

To create an event,

- 1 Open the application list and select **S Planner** → .
- 2 If alert messages about the calendar sync appear, select **Done**.

- 3 Select **Add event**, and then enter details.
  - To search for and add a location view, select .
  - To add a note, select **Notes** → an option.
  - To add an image, select **Images** → an option.
- 4 When you are finished, select **Save**.

To create a task,







- 1 Open the application list and select **S Planner** → .
- 2 Select **Add task**, and then enter details.
  - To add a note, select **Notes** → an option.
  - To add an image, select **Images** → an option.
- 3 When you are finished, select **Save**.

## › Change the view mode

To switch the calendar's view mode, select a view mode tab. You can also tap the screen with two fingers, and then pinch or spread them to change the view mode.

- 1 Open the application list and select **S Planner**.
- 2 Select a view mode at the top of the screen.
  - **Year**: Monthly blocks for the current year.
  - **Month**: Daily blocks for the current month.
  - **Week**: Hourly blocks for the days in one full week.
  - **Day**: Hourly blocks for one full day.
  - **List**: A list of all the events.
  - **Task**: A list of all the tasks.

## › View an event or task

- 1 Open the application list and select **S Planner**.
- 2 Select  to search for an event or task (if necessary).  
To limit the range of your search, select **All** → an option.
- 3 Select a date on the calendar.
  - To select today's date, select **Today**.
  - To switch to Multi Window mode, select .
  - To move to a specific day by entering a date manually, select  → **Go to**, enter the date by selecting  or , and then select **Set**.
  - To enable handwriting on the Month view mode, select  → **Enable Handwriting mode**.
  - To disable handwriting or delete the handwritten, select  → **Disable Handwriting mode**.
- 4 Select an event or task to view its details.

## › Stop an event alarm

If you set an alarm for a calendar event, the event alarm icon appears at the specified time.

- 1 Select the event notification from the notifications panel.
- 2 Select an event or task to view more details.  
To snooze or dismiss the event alarm, check the box next to the event or task name and select **Snooze** or **Dismiss**.

## Learn Quick Command feature

Learn how to make a call, send a message, or do a search using gestures.

While pressing S Pen button, drag the S Pen up to display the quick command panel.

Draw a gesture on the panel to launch an application.

### › Create gesture commands

- 1 Open the application list and select **Settings** → **S Pen** → **Quick Command settings**.
- 2 Select **Add a command** → **Select an application** or **Select functions**.
- 3 Select an application or a feature → an option.
- 4 Draw a gesture for a new gesture command, and then select **Done**.

### › Change gesture commands

- 1 Open the application list and select **Settings** → **S Pen** → **Quick Command settings**.
- 2 Select a gesture command to change.
- 3 Select  to change an application or a feature preset, or draw a new gesture to change the existing one, and then select **Done**.



If a new gesture command is the same with any of existing gesture commands, it cannot be effective.



## S Pen Air View

When you hold the S Pen near the screen, a pointer appears on the screen. Move the pointer to files, subjects, or options to preview the contents or view information in pop-up windows.

You can scroll through panels or lists by moving the pointer to an edge (top/bottom/left/right) of the screen.

## Capture screen area

- 1 While pressing S Pen button, select an area by drawing.
- 2 Select an application from the list of applications that appear on the bottom of screen to associate it with the selected area.

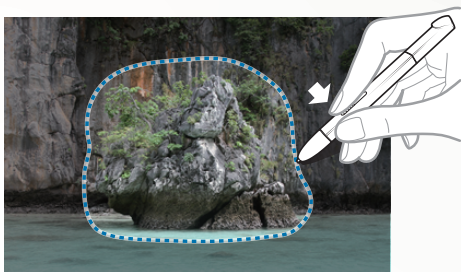

- The selected area is saved in the **Gallery** → **Screenshots** folder.
- The above screen may differ depending on your region or service provider.

# Web

## Internet

Learn to access and bookmark your favourite web pages.



- The web browser menu may be labelled differently depending on your region or service provider.
- Available icons may vary depending on your region or service provider.

### › Browse web pages

1 Open the application list and select **Internet** to launch your homepage.

To access a specific web page, select the URL input field, and then enter the web address of the web page.

2 Navigate web pages with the following keys:

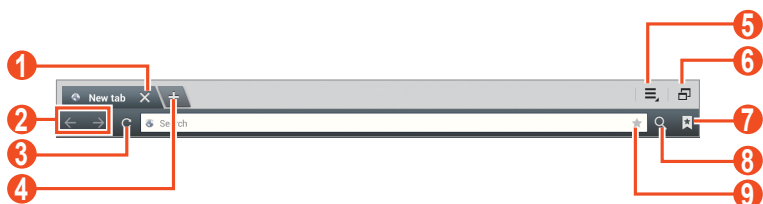

The above screen may differ depending on your region or service provider.



Number	Function
1	Close the current tab.
2	Move backward or forward to web pages in history.
3	Reload the current web page; While the device is loading web pages, this icon changes to  .
4	Open a new tab.
5	Access a list of web browser options.
6	Switch to Multi Window mode.
7	Open a list of saved bookmarks and recent internet history.
8	Search for information.
9	Bookmark the current web page.









While browsing a web page, use the following options:

- To zoom in or out, tap the screen with two fingers and spread them apart (move your fingers closer together to zoom out).



If you activate tilting motions, you can zoom in or out by tapping and holding two points with your fingers, and then tilting the device back and forth.

- To open a new tab, select  → **New tab.**
- To open a new tab without saving cookies, select  → **New incognito tab.**
- To add the bookmark shortcut to the Home screen, select  → **Add shortcut.**

- To send the web address of the web page to others, select  → **Share page**.
- To search for text on the web page, select  → **Find on page**.
- To switch to the desktop view, select  → **Desktop view**.
- To save the current web page and read it offline later, select  → **Save for offline reading**. You can view the saved pages by selecting  → **Saved pages**.
- To view the items downloaded from the web, select  → **Downloads**.
- To print the web page using a Wi-Fi or USB connection, select  → **Print**. Your device is compatible only with some Samsung printers.
- To customise browser settings, select  → **Settings**.

## ▶ Search for information by voice



This feature may be unavailable depending on your region or service provider.

- 1 Open the application list and select **Internet**.
- 2 Select the URL input field.
- 3 Select  and say a keyword into your device's microphone.

The device searches for information and web pages related with the keyword.

## › Open multiple pages



You can open multiple pages and switch back and forth between them.

- 1 Open the application list and select **Internet**.
- 2 Select  to open a new tab.
- 3 Access another web page on the new tab.
- 4 To switch back and forth between currently open tabs, select the title of a tab.

## › Bookmark your favourite web pages

If you know the web address of a web page, you can manually add a bookmark.

### Add a bookmark



- 1 Open the application list and select **Internet**.
- 2 Enter a web address or a navigate to a web page.
- 3 Select  →  to bookmark the current web page.  
You can also select  to bookmark the current web page.
- 4 Enter a name for the bookmark.
- 5 Enter the web address for your favourite web page, and then select a bookmark location to add (if necessary).
- 6 Select **OK**.

To use bookmark options, select  and tap and hold a bookmark:

- To open the web page in the current tab, select **Open**.
- To open the web page in a new tab, select **Open in new tab**.

- To edit the bookmark, select **Edit bookmark**.
- To add the bookmark shortcut to the Home screen, select **Add shortcut**.
- To send the web address of the web page to others, select **Share link**.
- To copy the web address of the web page, select **Copy link URL**.
- To delete the bookmark, select **Delete bookmark**.
- To use the web page as your homepage of the browser, select **Set as homepage**.

## Create a bookmark folder

- 1 Open the application list and select **Internet**.
- 2 Select  →  → .
- 3 Enter a name for the bookmark folder.
- 4 Select **Done**.

## > Access recent history

- 1 Open the application list and select **Internet**.
- 2 Select  → **History**.
- 3 Select a web page to access.

## Game Hub

Learn to access games.

- 1 Open the application list and select **Game Hub**.
- 2 Select a game service.
- 3 Search for and access games.



The games available may vary depending on your region or service provider.

## Play Books

Browse and download book files with Google Play Books. You can read book files on your device.

Open the application list and select **Play Books**.



This feature may be unavailable depending on your region or service provider.

## Play Store

Based on the Android platform, your device's functionality can be extended by installing additional applications. Play Store provides you an easy and quick way to shop for games and mobile applications.



- This feature may be unavailable depending on your region or service provider.
- Your device will save user files from downloaded applications to the internal memory.

## › Download and install an application

- 1 Open the application list and select **Play Store**.  
You can also select  → **Play Store** at the top right of the application list.
- 2 If you are launching this application for the first time, select **Accept**.
- 3 Search for an application and download it to the device.  
When the download is complete, the device will install the application automatically.

## › Uninstall an application

- 1 Open the application list and select **Play Store**.
- 2 Select .
- 3 Select the item you want to delete.
- 4 Select **Uninstall** → **OK**.

## YouTube

Learn to view and upload videos via YouTube.



 This feature may be unavailable depending on your region or service provider.

## › Watch videos

- 1 Open the application list and select **YouTube**.
- 2 Select a video.
- 3 Tap a video screen and select  to display a full screen.
- 4 Control playback with the virtual keys.



## › Upload videos

- 1 Open the application list and select **YouTube**.
- 2 Select  → **Sign in**, and then select your Google account if it is linked to YouTube. You can also select **Add account** and set up an account to sign in YouTube.
- 3 Select , and then select a video.
- 4 Enter details for the upload and select **Upload**.

## Video Hub

Learn to access videos.

 This feature may be unavailable depending on your region or service provider.









- 1 Open the application list and select **Video Hub**.
- 2 Select a category.
- 3 Search for and access videos.

## Maps



Learn to use Google Maps™ to find your location, search the map for streets, cities, or countries, and get directions.

-  • This feature may be unavailable depending on your region or service provider.
- You must activate location services to find your location and search the map. ► p. 123



## › Search for a specific location

- 1 Open the application list and select **Maps**.  
The map will display your current location.
- 2 Select .
- 3 Enter a keyword for the location.  
To search for a location by voice, select .
- 4 Select the location you want to view details.
  - To view the all of the search result, select **Search Results**.
  - To view your current location, select . To switch to the compass view of the map that changes orientation when you move the device, select .
  - To search for a place around you, select .
  - To get directions to a specific destination, select .
  - To add layers to the map, select .
  - To access a list of other options, select .
  - To zoom in or out, place two fingers on the screen and slowly spread them apart or pinch them together. You can also double-tap the screen. To return to the original size, double-tap the screen with two fingers.
  - To add a star to the location, select the balloon of the location name → .

## › Get directions to a specific destination

- 1 Open the application list and select **Maps**.
- 2 Select .
- 3 Enter the addresses of the starting location and the ending location.  
To enter an address from your contact list or starred places, or point the location on the map, select  → an option.
- 4 Select a travel method (car, bus, or walk) and select **Go**.  
The route is indicated on the map. Depending on the selected travel method, you may see multiple routes.
- 5 When you are finished, select  → **Clear Map**.

## › Share locations with friends



- 1 Open the application list and select **Maps**.
- 2 Select  → **Latitude**.  
The device automatically joins Latitude.
- 3 Select  → **Add friends** to select a friend you want to add from the contacts, or enter an email address.
- 4 Select **Yes**.  
When your friend accepts your invitation, you can share locations.
- 5 Select a friend from the list.  
Your friends' locations are marked with their photos on the map.

## Local

Learn to search for a place around you.



This feature may be unavailable depending on your region or service provider.

- 1 Open the application list and select **Local**.
- 2 Select a category.  
Your device searches for places around your current location that are related to the category.
- 3 Select a place name to view its details.
- 4 While viewing information, use the following options:
  - To view the place on the map, select .
  - To view the route to the place, select .

## Navigation

Learn to use the GPS navigation system to find and show your destination with voice guidance.



- Navigation maps, your current location, and other navigational data may differ from actual location information. You should always pay attention to road conditions, traffic, and any other factors that may affect your driving and follow all safety warnings and regulations while driving.
- This feature may be unavailable depending on your region or service provider.

- 1 Open the application list and select **Navigation**.
- 2 If you are launching this application for the first time, select **Accept**.
- 3 Enter your destination by using one of the following methods:
  - Speak your destination such as “Navigate to destination.”
  - Enter your destination with the virtual keypad.
  - Select your destination from addresses of your contacts.
  - Select your destination from the list of your starred places.
- 4 Follow the on-screen instructions to use the navigation service.

## Samsung Apps

Samsung Apps allows you to simply and easily download an abundance of applications directly to your device. Featuring a wealth of games, news, reference, social networking, navigation, health related applications and more, Samsung Apps gives you instant access to a huge choice of mobile experience.

Your device gets smarter with fully optimised applications from Samsung Apps. Explore amazing applications and make your mobile life even better.



- This feature may be unavailable depending on your region or service provider.
- For details, please visit [www.samsungapps.com](http://www.samsungapps.com).

- 1 Open the application list and select **Samsung Apps**.
- 2 Select your country.  
If you are launching this application for the first time, read the terms and conditions and select **Accept**.
- 3 Search for and download applications as desired.



## S Suggest

Find and download the latest applications suggested by Samsung. Open the application list and select **S Suggest**.

## Google

Learn to search for data in your device or information on the Internet.

### › Search for a keyword

- 1 Open the application list and select **Google**.
- 2 Enter a keyword and select  in keypad.  
To search for data by voice, select  and say a keyword into your device's microphone.
- 3 Select a search result.  
To limit the search scope, select  → **Settings** → **Tablet search** and then check the check box next to the applications to search for.

## › Use Google Now

Launch Google search to view Google Now cards that show the information you need at the right time.

Open the application list and select **Google**.



- This feature may be unavailable depending on your region or service provider.
- You must activate location services to find your location.
- To use this feature you need to sign in to your Google account.

## Learning Hub

Learn to access learning material.



This feature may be unavailable depending on your region or service provider.

- 1 Open the application list and select **Learning Hub**.
- 2 Select a category.
- 3 Search for and access video lectures or books.

# Communication



## Google Mail

You can retrieve new email messages from Google Mail™ to your Inbox. When you access this application, the Inbox screen appears. The total number of unread messages displays in the title bar and unread messages display in bold.



- This feature may be unavailable depending on your region or service provider.
- This Google Mail menu may be labelled differently depending on your region or service provider.

### ▶ Send an email message

- 1 Open the application list and select **Google Mail** → .
- 2 Select the recipient field and enter an email address.
- 3 Select the subject field and enter a subject.
- 4 Select the text field and enter your email text.
  - To attach a photo, select .
  - To remove an attached photo, select  to the right of an attachment's name.
- 5 Select **SEND** to send the message.



















If you are offline or outside your service area, the message will be held in the message thread until you are online and inside your service area.



## › View an email message

- 1 Open the application list and select **Google Mail**.
- 2 Select  to update the message list.
- 3 Select an email message.

From the message view, use the following options:

- To create a new message, select .
- To search for an email message, select .
- To archive the message, select .
- To delete the message, select .
- To move to the next or previous message, scroll left or right.
- To reply to the message, select .
- To reply to the message including all recipients, select .
- To forward the message to other people, select .
- To add a star to the message, select .
- To view an attachment, select **VIEW**. To save it to your device, select **SAVE**.
- To add a label to the message, select  → **Change labels**.
- To make the message as unread, select  → **Mark unread**.
- To mark the message as important, select  → **Mark as important**.
- To hide the message, select  → **Mute**. To move the message to the inbox folder, select **All Mail** and drag the message to **Inbox**.
- To register the message to the spam list, select  → **Report spam**.
- To reload the messages, select  → **Refresh**.
- To customise the settings for each label, select  → **Manage labels**.
- To customise the email settings, select  → **Settings**.



Available options may vary depending on the account.

# Email



Learn to send or view email messages via your personal or company email account.



## › Set up an email account

- 1 Open the application list and select **Email**.
- 2 Enter your email address and password.
- 3 Select **Next** (for general email accounts) or **Manual setup** (for other company email accounts).
- 4 Follow the on-screen instructions.
- 5 To add more email accounts, select  → **Settings** → **Add account** and repeat steps 2-4.

When you are finished setting up the email account, the email messages are downloaded to your device. If you have created more than two accounts, you can switch between email accounts. Select an account name at the top left of the screen and select the one you want to retrieve messages from.

## › Send an email message

- 1 Open the application list and select **Email** → .
- 2 Add recipients of your message.
  - Enter email addresses manually, separating them with a semicolon or a comma.
  - Select email addresses from the lists by selecting .
- 3 Select the subject field and enter a subject.
- 4 Select the text input field and enter your email text. You can enter draw a sketch by selecting .

- 5 Select  → files to attach.
- 6 Select  to send the message.  
To send the message at a specified time and date, select .











 If you are offline or outside your service area, the message will be held in the outbox until you are online and in your service area.





## ► View an email message

When you open an email account, you can view previously retrieved email offline or connect to the email server to view new messages. After retrieving email messages, you can view them offline.

- 1 Open the application list and select **Email**.
- 2 Select  to update the message list.
- 3 Select an email message.

From the message view, use the following options:

- To search for an email message, select .
- To reload the messages, select .
- To create a new message, select .
- To reply to the message, select .
- To reply to the message including all recipients, select .
- To forward the message to other people, select .
- To delete the message, select .
- To switch to Multi Window mode, select .
- To add a star to the message, select .
- To save the email addresses of the recipients to the phonebook as a group of contacts, select  →  → **OK**.

- To make the message as unread, select  → **Mark as unread**.
- To move the message to another folder, select  → **Move**.
- To save the message, select  → **Save email**. The message will be saved in **My Files** → **sdcard0** → **Saved Email**.
- To view the messages by category, select  → **Sort by**.
- To change the view mode, select  → **View mode**.
- To print the message using a Wi-Fi or USB connection, select  → **Print**. Your device is compatible only with some Samsung printers.
- To filter messages from the sender, select  → **Set as priority sender**. You can read messages from the sender in the specified inbox.
- To delete all messages, select  → **Delete all**.
- To change the font size, select  → **Font size**.
- To customise the email settings, select  → **Settings**.
- To save an attachment to your device, select the attachment tab → .



The options available may vary depending on the email account or device's orientation.

## Talk

Learn to chat with friends and family via Google Talk™.



This feature may be unavailable depending on your region or service provider.





### › Set your status

- 1 Open the application list and select **Talk**.
- 2 Add your Google account (if necessary).
- 3 Customise your status, image, and message to display.

## › Add friends to your friend list

- 1 Open the application list and select **Talk** → .
- 2 Enter an email address of the friend and select **DONE**.  
When your friend accepts the invitation, the friend is added to your friend list.

## › Start a chat

- 1 Open the application list and select **Talk**.
- 2 Select a friend from the friends list. The chat screen opens.
- 3 Enter and send your message.
  - To add more friends to a chat, select  → **Add to chat**.
  - To switch between active chats, select a friend from the friends list.
  - To use video chat, select, .
  - To use voice chat, select, .
  - To end the chat, select  → **End chat**.

## ChatON

Learn to use ChatON to send and receive instant messages from any device that has a mobile phone number.

- 1 Open the application list and select **ChatON**.  
 If you are launching this application for the first time, follow the on-screen instructions to complete the account setup.
- 2 Enter and send your message.

## Messenger

Learn to send and receive instant messages to friends and family with the Google+ messenger instant messaging service.

1 Open the application list and select **Messenger**.



If you are launching this application for the first time, follow the on-screen instructions to complete the account setup.

2 Enter and send your message.

## Google+

Learn to access the Google's social network service. You can create groups to share interests and thoughts or send and receive instant messages, and upload your photos.

1 Open the application list and select **Google+**.



If you are launching this application for the first time, follow the on-screen instructions to complete the account setup.

2 Select a social network feature.

# Entertainment

## Music Player

Learn to listen to your favourite music while on the go with the music player. The music player supports the following file formats: mp3, aac, ogg, wma, flac, m4a.



- You can also play music files in the following formats if you open them from My files or the web browser: mid, xmf, rtttl, imy, rtx, ota, amr, wav, mxmf.
- Some file formats are not supported depending on the software of the device.
- If the file size exceeds the available memory, an error can occur when you open files.
- Playback quality may vary by content type.
- Some files may not play properly depending on how they are encoded.

### ► Add music files to your device

Start by transferring files to your device or memory card:

- Download from the wireless web. ► p. 62
- Download from a PC with Samsung Kies. ► p. 110
- Receive via Bluetooth. ► p. 123
- Synchronise with Windows Media Player 11. ► p. 111
- Copy to your memory card.

## › Play music

After transferring music files to your device or memory card,

- 1 Open the application list and select **Music Player**.
- 2 Select a music category → a music file.
- 3 Tap the music player field.
- 4 Control playback with the virtual keys.

During playback, select  to access the following options:



- To add music files to a playlist, select **Add to playlist**.
- To listen to music via a Bluetooth headset, select **Via Bluetooth**. You cannot use this option when you connect a headset to your device.
- To send the music file to others or share it, select **Share via**.
- To set a music file as an alarm tone, select **Set as alarm tone**.
- To search for devices that have media sharing activated, select **Scan for nearby devices**.
- To change the music player settings, select **Settings**.



You can experience virtual 5.1 surround sound when listening to multichannel content, such as DVD movies.



## › Create a playlist

- 1 Open the application list and select **Music Player**.
- 2 Select  → **New playlist**.
- 3 Enter a title for your new playlist and select **OK**.
- 4 To add music files to the playlist, select  next to the music files.  
To delete music files from the playlist, select  next to the music files.
- 5 Select **Done**.

## › Customise music player settings

- 1 Open the application list and select **Music Player**.
- 2 Select  → **Settings**.
- 3 Adjust the following settings to customise your music player:

Option	Function
SoundAlive	Select a sound effect.
Play speed	Change the playback speed.
Lyrics	Set to display lyrics during playback.
Music auto off	Set the music player to turn off automatically after a specific period of time.
Music menu	Select music categories to display on the music library screen.

## Music Hub

You can access the online music store, and search for and buy your favourite songs. You can also add a music file to your wish list and play downloaded music files.



This feature may be unavailable depending on your region or service provider.

- 1 Open the application list and select **Music Hub**.
- 2 Select , and then enter a keyword to search for.
- 3 Select one from the list of search results.  
To buy an album, select the price tag, and then follow on-screen instructions to complete the purchase process.

## Camera

Learn how to capture and view photos and videos.



- The camera automatically turns off when you do not use it for a specified period.
- The memory capacity may differ depending on the shooting scene or shooting conditions.

## › Capture a photo

- 1 Open the application list and select **Camera**.
- 2 Aim the lens at the subject and make any necessary adjustments.

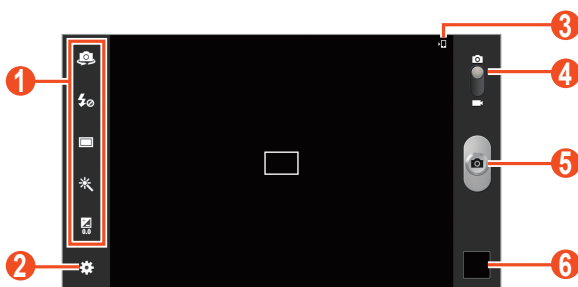





Number	Function
1	Use camera shortcuts. <ul style="list-style-type: none"><li>• : Switch between the front and rear camera lens.</li><li>• : Change the flash setting.</li><li>• : Change the shooting mode.</li><li>• : Apply a special effect.</li><li>• : Adjust the exposure value.</li></ul> You can add or remove shortcuts to frequently used options. ► p. 95
2	Change the camera settings.
3	View the storage location.
4	Switch to the camcorder.
5	Capture a photo.
6	View photos you have taken.











To zoom in, place two fingers on the screen and slowly spread them apart. To zoom out, pinch them together. You can also zoom in or out with the Volume key.

- 3 Tap where you want to focus on the preview screen. The focus frame moves to the place you tapped and changes to green when the subject is in focus.
- 4 Select  to take a photo. The photo is saved automatically.

After taking photos, select the image viewer to view the captured photos.

- To view more photos, scroll left or right. You can also tap the screen and scroll through the thumbnails of photos at the bottom of the screen.
- To zoom in or out, place two fingers on the screen and slowly spread them apart or pinch them together. To return to the original size, double-tap the screen.
- To add the photo to the favourites list, select .
- To send the photo to others, select  → an option.
- To delete the photo, select  → **OK**.
- To start a slide show, select  → **Slideshow** → **Start slideshow**. Tap the screen to stop the slide show.
- To register the faces in the photo as face tags, select  → **Face tag**. ► p. 101
- To add a note to the image, select  → **Add photo note**. Tap  in an image to edit the note.
- To add the photo to the clipboard, select  → **Copy to clipboard**.
- To rotate the photo anti-clockwise, select  → **Rotate left**.
- To rotate the photo clockwise, select  → **Rotate right**.

- To crop a section from the photo, select  → **Crop**.
- To edit the photo with the image editor, select  → **Edit**.
- To set the photo as your wallpaper or a contact image, select  → **Set as**.
- To send the photo to a person whose face is tagged in the photo, select  → **Buddy photo share**.
- To print the photo via Wi-Fi or USB, select  → **Print**. Your device is compatible only with some Samsung printers.
- To change the name of a file, select  → **Rename**.
- To search for devices that have media sharing activated, select  → **Scan for nearby devices**.
- To view photo details, select  → **Details**.

## › Change the shooting mode

You can take photos with various shooting modes. To change the shooting mode, select  → **Shooting mode** → an option.

Option	Function
Panorama	Take panoramic photos. This mode is available on the rear camera only.
Share shot	Take a photo and send it to others via Wi-Fi Direct.
Buddy photo share	Send the photo to a person whose face is tagged in the image.
Smile shot	Set the device to recognise people's faces and help you take photos of them when they smile.
Cartoon	Take photos with cartoon effects.

## › Customise camera settings

Before taking a photo, select  to access the following options:

Option	Function
Edit shortcuts	Edit shortcuts to frequently-used options.
Self portrait	Switch between the front and rear camera lenses.
Flash	Change the flash setting; You can manually turn the flash on or off, or set the camera to automatically use the flash when needed.
Shooting mode	Change the shooting mode.
Effects	Apply a special effect, such as sepia or black and white tones.
Scene mode	Change the scene mode.
Exposure value	Adjust the exposure value to change the brightness.
Focus mode	Take close-up photos or set the camera to focus on the subject automatically.
Timer	Select the length of the delay before the camera takes a photo.
Resolution	Change the resolution option.

Option	Function
White balance	Adjust the colour balance according to lighting conditions.
ISO	Adjust the sensitivity of the imaging sensor.
Metering	Select a type of exposure metre.
Outdoor visibility	Activate Outdoor visibility to select an appropriate lighting condition.
Guidelines	Display guidelines on the preview screen.
GPS tag	<p>Set the camera to include location information for your photos.</p> <ul style="list-style-type: none"> <li>• To improve GPS signals, avoid shooting in locations where the signal may be obstructed, such as between buildings or in low-lying areas, or in poor weather conditions.</li> <li>• Your location may appear on your photos when you upload them to the web. To avoid this, deactivate the GPS tag setting.</li> </ul>
Save as flipped	Set the camera to flip the image automatically when you take a photo with the front camera.
Image quality	Select a quality level for your photos.
Storage	Select a memory location for saving captured photos.
Reset	Reset camera settings.

## Record a video

- 1 Open the application list and select **Camera**.
- 2 Drag the slider to switch to the camcorder.
- 3 Aim the lens at the subject and make any necessary adjustments.

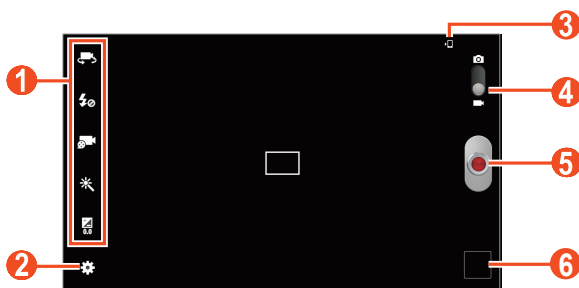



Number	Function
1	<p>Use camcorder shortcuts.</p> <ul style="list-style-type: none"><li>• : Switch to the front camera lens and record a video of yourself.</li><li>• : Change the flash setting.</li><li>• : Change the recording mode (for attaching to a message or for saving normally).</li><li>• : Apply a special effect.</li><li>• : Adjust the exposure value.</li></ul> <p>You can add or remove shortcuts to frequently used options. ► p. 95</p>
2	Change the camcorder settings.
3	View the storage location.
4	Switch to the camera.











Number	Function
5	Record a video.
6	View videos you have recorded.



To zoom in, place two fingers on the screen and slowly spread them apart. To zoom out, pinch them together. You can also zoom in or out with the Volume key.

- 4 Tap where you want to focus on the preview screen. The focus frame moves to the place you tap and changes to green when the subject is in focus.
- 5 Select  to start recording.
- 6 Select  to stop recording.  
The video is saved automatically. To pause recording, select .

After recording videos, select the image viewer to view the recorded videos.

- To view more videos, scroll left or right. You can also tap the screen and scroll through the thumbnails of videos at the bottom of the screen.
- To play the video, select .
- To add the video to the favourites list, select .
- To send the video to others, select  → an option.
- To delete the video, select  → **OK**.
- To start a slide show, select  → **Slideshow** → **Start slideshow**. Tap the screen to stop the slide show.
- To change the name of a file, select  → **Rename**.
- To search for devices that have media sharing activated, select  → **Scan for nearby devices**.
- To view video details, select  → **Details**.

## › Customise camcorder settings

Before recording a video, select  to access the following options:

Option	Function
Edit shortcuts	Edit shortcuts to frequently used options.
Self recording	Switch between the front and rear camera lenses.
Flash	Change the flash setting; You can manually turn the flash on or off.
Recording mode	Change the recording mode.
Effects	Apply a special effect, such as sepia or black and white tones.
Exposure value	Adjust the exposure value to change the brightness.
Timer	Select the length of the delay before the camera starts recording a video.
Resolution	Change the resolution option.
White balance	Adjust the colour balance according to lighting conditions.
Outdoor visibility	Activate Outdoor visibility to select an appropriate lighting condition.
Guidelines	Display guidelines on the preview screen.
Save as flipped	Set the camcorder to flip the image automatically when you record a video with the front camera.
Video quality	Select a quality level for your videos.
Storage	Select a memory location for saving recorded videos.
Reset	Reset camcorder settings.

## › Edit the shortcut icons

You can add or remove shortcuts to frequently-used options.

- 1 From the preview screen, select  → **Edit shortcuts**.
- 2 Tap and hold an icon from the option list and drag it to the shortcut area.  
To remove shortcuts, tap and hold an icon and drag it to the option list.
- 3 Tap the screen to return to the preview screen.

## Video Player

Learn to use the video player.



- Some file formats are not supported depending on the device's software.
- If a file size exceeds the memory available, an error may occur when you try to open the file.
- Playback quality may vary by content type.
- Some files may not play properly depending on how they are encoded.

## › Play a video

- 1 Open the application list and select **Video Player**.
- 2 Select a video.

### 3 Control playback with the following keys.

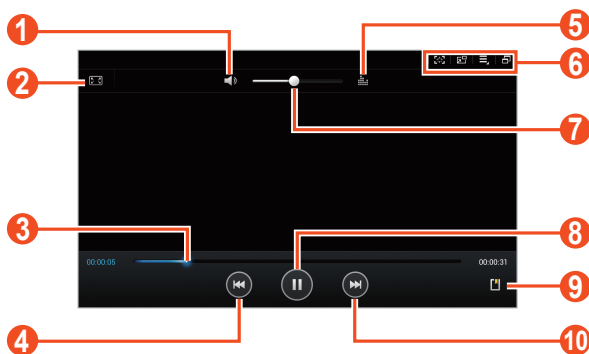















The above screen may differ depending on your region or service provider.

Number	Function
1	Mute the video.
2	Change the ratio of the video screen.
3	Scan forwards or backwards in the file by dragging or tapping the bar.
4	Restart playback; Skip to the previous file (double-tap); Scan backwards in the file (tap and hold).
5	Select a sound effect.
6	Switch to the floating screen mode; Capture a screenshot; Access video player options; Switch to Multi Window mode.
7	Adjust the volume.

Number	Function
8	Pause playback; Select  to resume playback.
9	Insert a bookmark.
10	Skip to the next file; Scan forwards in the file (tap and hold).

While playing a video, use the following options:

- To switch to the floating screen mode, select . You can move the screen by tapping and holding it. To return to the full screen mode, double tap the screen.
- To capture the video screen, select . The captured image is saved in **Gallery** → **Screenshots**.
- To send the video to others or share it, select  → **Share via**.
- To divide the video into segments, select  → **Chapter preview**. You can search for a segment and skip directly to that point.
- To trim a segment of the video, select  → **Trim**.
- To listen to audio via a Bluetooth headset, select  → **Via Bluetooth**.
- To export the current video to Video Editor, select  → **Video Editor**.
- To view your bookmarks, select  → **Bookmarks**. This option appears only if you have bookmarked during playback by selecting .

- To view video details, select  → **Details**.
- To set the video player to turn off automatically after a specific period of time, select  → **Video auto off**.
- To search for devices that have media sharing activated, select  → **Scan for nearby devices**.
- To change the video player settings, select  → **Settings**.
- To switch to Multi Window mode, select .

## ▶ Customise video player settings

1 During playback, select  → **Settings**.

2 Change the following options:

Option	Function
Play speed	Change the playback speed.
Subtitles	Customise the settings for a subtitle file.
Auto play next	Set the video player to play the next file automatically.
Colour tone	Select a colour tone.
Outdoor visibility	Set to improve the contrast of the display in bright sunlight.

## Gallery

Learn to view photos and play videos saved in your device's memory.



- Avoid locking the device's screen while playing a DivX Video-On-Demand. Each time you lock the screen while playing a DivX Video-On-Demand, one of your available rental counts will be decremented.
- Some file formats are not supported depending on the software of the device.
- If the file size exceeds the available memory, an error can occur when you open files.
- Playback quality may vary by content type.
- Some files may not play properly depending on how they are encoded.

### › View a photo

1 Open the application list and select **Gallery**.

2 Select a folder → an image.

While viewing a photo, use the following options:

- To view more photos, scroll left or right.
- To zoom in or out, place two fingers on the screen and slowly spread them apart or pinch them together. You can also double-tap the screen. To return to the original size, double-tap the screen.







If you activated tilting motions, you can zoom in or out by tapping and holding two points with your fingers, and then tilting the device back and forth.

- To add the photo to the favourites list, select .
- To send the photo to others, select  → an option.
- To delete the photo, select  → **OK**.
- To start a slide show, select  → **Slideshow** → **Start slideshow**. Tap the screen to stop the slide show.
- To register the faces in the photo as face tags, select  → **Face tag**.
- To add a note to the image, select  → **Add photo note**. Tap  in an image to edit the note.
- To add the photo to the clipboard, select  → **Copy to clipboard**.
- To rotate the photo anti-clockwise, select  → **Rotate left**.
- To rotate the photo clockwise, select  → **Rotate right**.
- To crop a section from the photo, select  → **Crop**.
- To edit the photo with the image editor, select  → **Edit**.
- To set the photo as your wallpaper or a contact image, select  → **Set as**.
- To send the photo to a person whose face is tagged in the photo, select  → **Buddy photo share**.
- To print the photo via Wi-Fi or USB, select  → **Print**. Your device is compatible only with some Samsung printers.
- To change the name of a file, select  → **Rename**.
- To search for devices that have media sharing activated, select  → **Scan for nearby devices**.
- To view photo details, select  → **Details**.
- To switch to Multi Window mode, select .





## › Create a new photo album

- 1 Open the application list and select **Gallery**.
  - 2 Select  → **New album**.  
You can also select  to create a new album after selecting a category.
  - 3 Enter a name and select **OK**.
  - 4 Select a folder in the left panel, and then select image to move or copy in the right panel.
  - 5 Tap and hold images you selected and then drag them to the new album.
  - 6 Select **Save** → **Move** or **Copy**.
-  Web photo albums on Google or social networks are automatically synchronised with the device. To allow synchronising only via Wi-Fi network, select  → **Settings**, and then check the check box next to **Sync only via Wi-Fi**.

## › Tag a face in an image



Learn to tag faces in your images to make calls, send messages, and upload messages to social networks with the face tag shortcuts.

-  Learn to tag faces in your images to send email messages via Google Mail or Email, and upload messages to social networks with the face tag shortcuts.
- 1 Open the application list and select **Gallery**.
  - 2 Select an image.
  - 3 Select  → **Face tag** → **On**.  
Recognised faces appear in the frame.

- 4 Select a recognised face → **Add name**.
- 5 Select the person's name from the contact list.  
The contact is linked to the face in the image.

When the face tag appears with a name, select the face tag and use the available options.

## ▶ Play a video

- 1 Open the application list and select **Gallery**.
- 2 Select a folder → a video (indicated by the  icon).
- 3 Select  to begin playback.
- 4 Control playback with the keys. ▶ p. 95

During playback, select  to access the following options:

- To send the video to others or share it, select **Share via**.
- To divide the video into segments, select **Chapter preview**.  
You can search for a segment and skip directly to that point.
- To trim a segment of the video, select **Trim**.
- To listen to audio via a Bluetooth headset, select **Via Bluetooth**.
- To export the current video to Video Editor, select **Video Editor**.
- To view your bookmarks, select **Bookmarks**. This option appears only if you have bookmarked during playback by selecting .
- To view video details, select **Details**.
- To search for devices that have media sharing activated, select **Scan for nearby devices**.
- To change the video settings, select **Settings**.

## Paper Artist

Learn to make images look like illustrations with fun effects or frames. Open the application list and select **Paper Artist**.





- The edited image will be saved in **Gallery** → **Paper Pictures**.
- This feature may be unavailable depending on your region or service provider.

## Video Editor

You can edit videos and apply various effects.

### › Create a video



- 1 Open the application list and select **Video Editor**.
- 2 Select  (if necessary).
- 3 Select a frame theme.
- 4 Select **Add media**.
- 5 Select a category in the left panel and then select images, videos, and audios to make video, and then **Done**.
  - To delete images or videos, tap and hold an item, and then drag it to the rubbish bin.
  - To rearrange images or videos, tap and hold an item, and then drag it to a new location.
  - To trim a segment of an image or video, tap an item, and then drag the brackets to the left or right.
  - To adjust volume of each sound effect, select **Sound**, and then move the equalizer bars.

- 6 Select  → a transition effect option.
- 7 When you are finished, select  → **Export**.
- 8 Select a resolution option.
- 9 Enter a name for the video and select **OK**.

## › Trim a segment of a video

- 1 Open the application list and select **Video Editor**.
- 2 Tap an item to edit in the timeline.
- 3 Move the start bracket to the point where trimming should begin.
- 4 Move the end bracket to the point where the trimming should end.
- 5 Select  → **Save**.

## › Split a video

- 1 Open the application list and select **Video Editor**.
- 2 Tap an item to edit in the timeline. You can only split images or videos.
- 3 Drag the thumbnail to place in the black dotted line at the desired point.
- 4 Select .
- 5 Select  → **Save**.



## › Apply an effect to a video

- 1 Open the application list and select **Video Editor**.
- 2 Tap an item to edit in the timeline.
- 3 Select **Visual effects** → an effect option.
- 4 Select  → **Save**.

## › Add a caption to a video

- 1 Open the application list and select **Video Editor**.
- 2 Drag the thumbnail to place in the black dotted line at the desired point.
- 3 Select **Text** → a text option.
- 4 Enter text.
- 5 Select  → **Save**.





## › Insert a drawing in a video

- 1 Open the application list and select **Video Editor**.
- 2 Drag the thumbnail to place in the black dotted line at the desired point.
- 3 Select **Pen** → an option, and then draw on the screen.
  - To undo your last action, select .
  - To redo your last action, select .
- 4 When you are finished, select **Done**.
- 5 Select  → **Save**.

## › Insert a sound effect to a video

- 1 Open the application list and select **Video Editor**.
- 2 Drag the thumbnail to place in the black dotted line at the desired point.
- 3 Select **Sound effects** → a sound option.
- 4 Select  → **Save**.

## › Insert narration to a video

- 1 Open the application list and select **Video Editor**.
- 2 Drag the thumbnail to place the black dotted line at the desired point, and then select **Record**.
- 3 Select  to start voice recording.
- 4 Select  to stop voice recording.
  - To pause voice recording, select .
  - To cancel voice recording and delete it, select .
- 5 Select  → **Save**.

# Personal information

## Contacts

Learn to create and manage a list of your personal or business contacts. You can save names, mobile phone numbers, home phone numbers, email addresses, birthdays and more for your contacts.





### › Create a contact

- 1 Open the application list and select **Contacts**.
- 2 Select **Contacts** → **+**.
- 3 Select a memory location.
- 4 Enter contact information.
- 5 Select **Save** to add the contact to memory.

### › Find a contact

- 1 Open the application list and select **Contacts**.
- 2 Select **Contacts**.
- 3 Scroll up or down the contact list.  
You can also find a contact by entering a few letters in the text input field at the top of the contact list.
- 4 Select a contact's name.

Once you find a contact, you can use the following options:

- To edit the contact information, select .
- To delete the contact, select  → **OK**.
- To send an email message, select .
- To set the contact as your favourites, select .

## ▶ Import or export contacts

You can import or export files (in vcf format) to or from your device's USB storage or a memory card.

### Import contact files

- 1 Open the application list and select **Contacts**.
- 2 Select **Contacts**.
- 3 Select  → **Import/Export** → **Import from SD card** or **Import from USB storage**.
- 4 Select a memory location.  
If you have more than one account, select an account to which you want to add the contact.
- 5 Select an option for importing a single contact file, multiple contact files, or all contact files, and select **OK**.
- 6 Select contact files to import and select **OK**.

### Export contact files

- 1 Open the application list and select **Contacts**.
- 2 Select **Contacts**.
- 3 Select  → **Import/Export** → **Export to SD card** or **Export to USB storage**.
- 4 Select **OK** to confirm.



## › Create your namecard

- 1 Open the application list and select **Contacts**.
- 2 Select **Contacts**.
- 3 Select **Set up my profile** at the top of the contact list.
- 4 Enter your personal details and select **Save**.

 You can send your namecard to others by selecting  → **Share namecard via**.

## › Create a group of contacts

- 1 Open the application list and select **Contacts**.
- 2 Select **Groups** → .
- 3 Enter a name and customise the settings for the group.
- 4 Select **Add member**.
- 5 Select members from the contact list and select **Done**.
- 6 When you are finished, select **Save**.

# Connectivity

## PC connections

Learn to connect your device to a PC with a USB cable in various USB connection modes. By connecting the device to a PC, you can synchronise files with Windows Media Player, transfer data to and from your device directly, and use the Samsung Kies program.



Do not disconnect the USB cable from a PC while the device is transferring or accessing data. Doing so may result in data loss or damage to the device.



For best results, connect the USB cable directly to a USB port on a PC. Data transfers may fail when using a USB hub.

### › Connect with Samsung Kies

Ensure that Samsung Kies is installed on your PC. You can download the program from the Samsung website.



Samsung Kies will work on both Windows and Macintosh computers.

- 1 Connect your device to a PC with a USB cable. Samsung Kies will launch automatically. If Samsung Kies does not launch automatically, double-click the Samsung Kies icon on your PC.
- 2 Copy files from the PC to the device. Refer to the Samsung Kies help for more information.

## › Synchronise with Windows Media Player

Ensure that Windows Media Player is installed on your PC.

- 1 Connect your device to a PC with a USB cable.
- 2 Open Windows Media Player and synchronise music files.

## › Connect as a media device

You can connect your device to a PC and access media files stored on your device.

- 1 Connect your device to a PC with a USB cable.
- 2 Select the right side of the system bar, and then select **Connected as a media device** → **Media device (MTP)**.
- 3 Transfer files between your device and the PC.

## › Connect as a camera device

You can connect your device to a PC as a camera and access files in your device.

 Use this USB connection mode when your PC does not support the media transfer protocol (MTP) or does not have the USB driver for your device installed.

- 1 Connect your device to a PC with a USB cable.
- 2 Select the right side of the system bar, and then select **Connected as a media device** → **Camera (PTP)**.
- 3 Transfer files between your device and the PC.

## Wi-Fi

Learn to use your device's wireless networking capabilities to activate and connect to any wireless local area network (WLAN) compatible with the IEEE 802.11 a/b/g/n standards. You can connect to the internet or other network devices anywhere an access point or wireless hotspot is available.



Your device uses a non-harmonised frequency and is intended for use in all European countries. The WLAN can be operated in the EU without restriction indoors, but cannot be operated outdoors.

### ▶ Activate the Wi-Fi feature

Open the application list, select **Settings**, and then drag the **Wi-Fi** switch to the right.



The Wi-Fi feature running in the background will consume battery power. To preserve battery power, activate the feature only when needed.

### ▶ Find and connect to a Wi-Fi network

- 1 Open the application list and select **Settings** → **Wi-Fi**. The device will automatically search for available Wi-Fi networks.
- 2 Select a network under **Wi-Fi networks**.
- 3 Enter a password for the network (if necessary).
- 4 Select **Connect**.

## ➤ Add a Wi-Fi network manually

- 1 Open the application list and select **Settings** → **Wi-Fi** → **Add Wi-Fi network**.
- 2 Enter an SSID for the network and select a security type.
- 3 Set the security settings depending on the selected security type.
- 4 Select **Save**.

## ➤ Connect to a Wi-Fi network using a Wi-Fi Protected Setup (WPS)

Using WPS, you can connect to a secured network.

### Connect with a WPS button

- 1 Open the application list and select **Settings** → **Wi-Fi**.
- 2 Select a network indicated as WPS available under **Wi-Fi networks**.
- 3 Enter a password for the network → **Connect**, and then select  → **WPS push button**.
- 4 Press a WPS button on the access point within 2 minutes.

### Connect with a WPS PIN

- 1 Open the application list and select **Settings** → **Wi-Fi**.
- 2 Select a network indicated as WPS available under **Wi-Fi networks**.
- 3 Enter a password for the network → **Connect**, and then select  → **WPS PIN entry**.
- 4 On the access point, enter the PIN and press the start button.

## › Set the static IP settings

- 1 Open the application list and select **Settings** → **Wi-Fi**.
- 2 Select a network under **Wi-Fi networks**, and then check the check box next to **Show advanced options**.
- 3 Select the drop-down menu under **IP settings**.
- 4 Select **Static**.
- 5 Change the IP settings for the network such as IP address, Gateway, Network prefix length, DNS.
- 6 Select **Connect**.

## › Customise Wi-Fi settings

- 1 Open the application list select **Settings** → **Wi-Fi** →  → **Advanced**.
- 2 Change the following options:

Option	Function
Network notification	Set the device to notify you when an open Wi-Fi network is available.
Keep Wi-Fi on during sleep	Set whether or not to keep the Wi-Fi feature active in Sleep mode.
Wi-Fi timer	Set the time to turn the Wi-Fi feature on or off.
MAC address	View the MAC address for the device.
IP address	View the IP address for the current network.

## Wi-Fi Direct

Learn to use the Wi-Fi Direct feature to connect two devices via Wi-Fi without requiring an access point.



This feature is activated only when Wi-Fi feature is on.

### › Connect your device to another device

- 1 Open the application list and select **Settings** → **Wi-Fi**.
- 2 Drag the **Wi-Fi** switch to the right to turn on the Wi-Fi network.
- 3 Select **Wi-Fi Direct**.
- 4 Select **Scan** → a device.  
When the owner of the other device accepts the connection, the devices are connected.

### › Send data via Wi-Fi

- 1 Select a file or item from an appropriate application.
- 2 Select an option for sending data via Wi-Fi.



The method for selecting an option may vary by data type.

- 3 Search for and select another device.

### › Receive data via Wi-Fi

When you receive data, it is saved to your device automatically. Received data is saved to the ShareViaWifi folder.

## AllShare Cast

Learn to connect your device to a large screen by using an AllShare Cast dongle, and then share your contents.



- This feature may be unavailable depending on your region or service provider.
- Some files may be buffered while playing depending on the network connection.
- If you specify a Wi-Fi frequency band (5 GHz or 2.4 GHz), AllShare Cast dongles may not be found or connected.
- If you play videos or games with a TV, select an appropriate TV mode to get the best experience with AllShare Cast.

- 1 Open the application list and select **Settings** → **More settings** → **AllShare Cast**.
- 2 Drag the **AllShare Cast** switch to the right.
- 3 Select a device.  
When the devices are connected, you can see your device's display on the other's display.
- 4 Open or play a file.
- 5 Control the display with the keys on your device.



## AllShare Play

You can play and send any file between registered devices, or registered web storage via AllShare Play.

To use the AllShare Play service, you must sign in to your Samsung account, and register two or more devices as file servers. The registration methods may vary depending on the device type. To get more details about using AllShare Play, select  → **FAQ**.

 This feature may be unavailable depending on your region or service provider.

### › Send a file

- 1 Open the application list and select **AllShare Play**.
- 2 Select a registered device or storage that contains media files.
- 3 Select a media category and select the check box on a file.
- 4 Select .
- 5 Select a registered device or storage to save the file.

### › Share a file

- 1 Open the application list and select **AllShare Play**.
- 2 Select a registered device or storage that contains media files.
- 3 Select a media category and select the check box on a file.
- 4 Select , and then choose a share option.

## › Play a file on a nearby device



- Supported file formats may differ depending on connected devices as a media player.
- Some files may be buffered while playing depending on the network connection.

- 1 Open the application list and select **AllShare Play**.
- 2 Select a registered device or storage that contains media files.
- 3 Select a media category and select the check box on a file.
- 4 Select
- 5 Select a device to use as a media player.
- 6 Control playback with the keys on your device.

## › Use the Group Cast feature

You can share screens with multiple other devices that are connected to the same Wi-Fi AP.

- 1 Open the application list and select **AllShare Play**.
- 2 Select a media category and select the check box on a file.
- 3 Select → **Group Cast**.
- 4 Enter a PIN and select **Done**.

## › Manage contents on a registered device or storage

- 1 Open the application list and select **AllShare Play**.
- 2 Select a registered device or storage.
- 3 View and manage your files.

## › Customise AllShare Play settings

- 1 Open the application list and select **AllShare Play**.
- 2 Select  → **Settings**.
- 3 Change the following options:

Option	Function
Registered storage	View registered storages that have been added to AllShare Play.
Registered devices	View or edit devices that have been added to AllShare Play.
Setting up web services	Sign in to social network sites to upload files.
Auto upload photos from mobile	Set to upload photos to the registered storage automatically when you sign in.
Video quality settings	Set to optimise the video quality for your device when playing videos saved on a computer.
Lock AllShare Play	Set to lock AllShare Play with the password for your Samsung account.
Language	Select a display language.
About	View AllShare Play information.

## Group Cast

You can share images, documents, and music with other devices that are connected to the same Wi-Fi AP.

 This feature may be unavailable depending on your region or service provider.

### › Share a file

1 Open the application list and select **Group Cast**.

2 Select a media type under **Start** to share with other devices.

 If your device has not connected to a Wi-Fi AP, make the network connection by selecting **Not connected**.

3 Select the files to share, and then select **Done**.

4 Enter a PIN, and then start Group Cast.

### › Join another Group Cast

1 Open the application list and select **Group Cast**.

2 Select a shared media under **Join**, enter the PIN code, and then select **OK**.

# Bluetooth

Bluetooth is a short-range wireless communications technology capable of exchanging information over a distance of about 10 m without requiring a physical connection.

You do not need to line up the devices to beam information with Bluetooth. If the devices are within range of one another, you can exchange information between them even if they are located in different rooms.



- Samsung is not responsible for the loss, interception, or misuse of data sent or received via the Bluetooth wireless feature.
- Always ensure that you share and receive data with devices that are trusted and properly secured. If there are obstacles between the devices, the operating distance may be reduced.
- Some devices, especially those that are not tested or approved by Bluetooth SIG, may be incompatible with your device.
- Do not use the Bluetooth feature for illegal purposes (for example, pirating copies of files or illegally tapping communications for commercial purposes). Samsung is not responsible for the repercussions of illegal use of the Bluetooth feature.

## › Turn on the Bluetooth wireless feature

- 1 Open the application list and select **Settings** → **Bluetooth**.
- 2 Drag the **Bluetooth** switch to the right to turn on the Bluetooth feature.

## › Find and pair with another devices



- 1 Open the application list and select **Settings** → **Bluetooth** → **Scan**.
- 2 Select a device.
- 3 Select **OK** to match the Bluetooth PIN between two devices. Alternately, enter a Bluetooth PIN and select **OK**. When the owner of the other device enters the same PIN or accepts the connection, pairing is complete. If the pairing is successful, the device will automatically search for available services.

 Some devices, especially headsets or hands-free car kits, may have a fixed Bluetooth PIN, such as 0000. If the other device has a PIN, you must enter it.

## › Send data via Bluetooth

- 1 Select a file or item from an appropriate application.
  - 2 Select an option for sending data via Bluetooth.
-  The method for selecting an option may vary by data type.
- 3 Search for and pair with a Bluetooth-enabled device.

## › Receive data via Bluetooth



- 1 Open the application list and select **Settings** → **Bluetooth**, and then check the check box next to your device name.  
 To select the length of time that your device will be visible, select  → **Visibility timeout**.
- 2 When prompted, enter the PIN for the Bluetooth wireless feature and select **OK** (if necessary).
- 3 Select **Accept** to confirm the connection between two devices.

Received data is saved in **My Files** → **sdcard0** → **Bluetooth**. If you receive a contact file, it is saved to the contact list automatically.

## GPS

Your device is equipped with a global positioning system (GPS) receiver. Learn to activate location services.

To receive better GPS signals, avoid using your device in the following conditions:

- Between buildings, in tunnels or underground passages, or inside buildings
  - In poor weather
  - Around high voltage or electromagnetic fields
  - In a vehicle with sun protection film
-  Do not touch or cover the antenna area with your hands or other objects while using the GPS functions.
-  This feature may be unavailable depending on your region or service provider.

## › Activate location services

You must activate location services to receive location information and search the map.

- 1 Open the application list and select **Settings** → **Location services**.
- 2 Change the following options:

Option	Function
Use wireless networks	Set to use Wi-Fi and/or mobile networks for finding your location.
Use GPS satellites	Set to use the GPS satellite for finding your location.
Location and Google search	Set the device to use your current location for Google search and other Google services.

## TV connections

You can control a TV remotely with your device to browse your favourite shows and get programming suggestions based on your choices. You can also control other devices connected to the TV.

### › Set your device as a remote control for a TV

You must first connect your device to a Wi-Fi AP and ensure that the device's infrared port is facing the TV.

- 1 Open the application list and select **Smart Remote**.
- 2 If you are launching this application for the first time, select **Agree**.



- 3 Rotate the device anti-clockwise to landscape orientation.
- 4 Select an option next to **Set Up Smart Remote Now:**
- 5 Select **Choose Brand** → the brand of your TV.
- 6 Select **Test Power On/Off** → **Yes** to check the connection between your device and TV.
- 7 Select **Done**.  
To add other devices, select **Add New Device**.
- 8 Control your TV or other devices with the icons on your device.

## › Customise remote control settings

- 1 Open the application list and select **Smart Remote**.
- 2 Select .
- 3 Change the following options:

Option	Function
Television	Change command codes if you have problems with a particular control.
Add New Device	Set up connections to peripheral devices connected to the TV.
Reset Peel	Reset the connection settings.
Send Feedback	Report your opinion for application development.

# VPN connections

You can create virtual private networks (VPN) and connect to your private network securely through a public network, such as the internet.



- Your device should already be configured with internet access. If you have trouble accessing the internet, you need to edit connections. If you are not sure about the connection information to enter, ask your service provider.
- To use this feature, you must activate the screen lock feature.

## › Set up VPN connections

- 1 Open the application list and select **Settings** → **More settings** → **VPN** → **Add VPN network**.
- 2 Change the following options:

Option	Function
Name	Enter a name for the VPN server.
Type	Select a VPN type.
Server address	Enter the IP address of the VPN server.
L2TP secret	Enter an L2TP secret password.
IPSec identifier	Enter a user name.
IPSec pre-shared key	Enter a pre-shared security key.
IPSec user certificate	Select a user certificate that the VPN server will use to identify you. You can import certificates from the VPN server or download them from the Internet.

Option	Function
IPSec CA certificate	Select a certificate authority (CA) certificate that the VPN server will use to identify you. You can import certificates from the VPN server or download them from the Internet.
IPSec server certificate	Select a server certificate that the VPN server will use to identify you. You can import certificates from the VPN server or download them from the Internet.
PPP encryption (MPPE)	Set to encrypt data before sending it to the VPN server.
Show advanced options	Set to change the advanced network settings.



The options available may vary depending on the VPN type.

3 When you are finished, select **Save**.

## ▶ Connect to a private network

1 Open the application list and select **Settings** → **More settings** → **VPN**.

2 Select a private network.

3 Enter the user name and password and select **Connect**.

# Tools

## Alarm



Learn to set and control alarms for important events.

### › Set a new alarm



- 1 Open the application list and select **Alarm** → .
- 2 Set alarm details.  
Check the check box next to **Smart alarm** to activate simulated nature sound prior to the main alarm.
- 3 When you are finished, select **Save**.

### › Stop an alarm

When the alarm sounds,

- To stop the alarm, drag  in any direction until it reaches the border of the circle.
- To repeat the alarm after a specified length of time, drag  in any direction until it reaches the border of the circle.

### › Delete an alarm

- 1 Open the application list and select **Alarm** → .
  - 2 Check the check box next to an alarm, and then select **Delete**.
-  • You can delete alarms by tapping and holding an alarm and selecting **Delete**.
  - To deactivate an alarm, select the clock icon next to the alarm.



## Calculator

Learn to perform mathematical calculations directly on your device like a typical hand-held or desktop calculator.

- 1 Open the application list and select **Calculator**.
- 2 Use the keys that correspond to the calculator display to perform a basic or scientific calculator.

## Downloads

Learn to manage logs of files you have downloaded from the web.

- 1 Open the application list and select **Downloads**.
- 2 Select a download category.
- 3 To open a downloaded file, select the log.
  - To delete a log, check the check box, and then select .
  - To share a downloaded file to others, check the check box, and then select .

## Dropbox

Learn to use the Dropbox cloud storage service to save and share your files with others. When you save files to your Dropbox folder, your device automatically synchronise with the web server and any other PCs that have Dropbox installed.



If you are a new user, create an account.

## › Activate Dropbox

- 1 Open the application list and select **Dropbox** → **Start**.
- 2 Enter an email address and password, and then select **Log in**.
- 3 Select **Next** → **Turn on**.

## › Upload files to your Dropbox folder

- 1 Open the application list and select **Dropbox**.
- 2 Select  → **Photos or videos** or **Other files**.
- 3 Select files.
- 4 Select **Dropbox** → a folder.
- 5 Select **Upload**.  
The files in the folder will be added to the web server and your PCs at home.

## › View a file

- 1 Open the application list and select **Dropbox** → .
- 2 Select a file.

## My Files

Learn to quickly and easily access all of your images, videos, music, sound clips, and other types of files stored on your device.

### › Supported file formats



Your device supports the following file formats:

Type	Format
Image	BMP, GIF, JPG, PNG
Video	MP4, 3GP, AVI, WMV, ASF, MKV, FLV, WEBM
Music	MP3, AAC, OGG, FLAC, MP4, 3GP, M4A, WMA, WAV, IMY, MID, XMF, OTA



- Some file formats are not supported depending on the software of the device.
- If the file size exceeds the available memory, an error can occur when you open files.
- Playback quality may vary by content type.
- Some files may not play properly depending on how they are encoded.



### › Open a file

- 1 Open the application list and select **My Files**.
- 2 Select a folder.
  - To move up one level in the file directory, select .
  - To return to the top level of the file directory, select .
- 3 Select a file to open.

## › Create a folder

- 1 Open the application list and select **My Files**.
- 2 Select .
- 3 Enter a name and select **Done**.

## › Copy or move files

- 1 Open the application list and select **My Files**.
- 2 Check the check box next to folders or files to copy or cut.
- 3 Select  or .
- 4 Locate a folder and select .

## › Send files

- 1 Open the application list and select **My Files**.
- 2 Check the check box next to files to send.
- 3 Select  → an option.

## › Delete files

- 1 Open the application list and select **My Files**.
- 2 Check the check box next to folders or files to delete.
- 3 Select  → **Yes**.



# Polaris Office

Learn to create or view Microsoft Word, Excel, PowerPoint, and Adobe PDF files on your device.





## ▶ Create a new document

1 Open the application list and select **Polaris Office**.

 If you are launching this application for the first time, register as an online user or skip the registration.

2 Select  → a document type.

3 Enter contents in the document.





- To undo your last action, select .
- To redo your last action, select .
- To insert an object such as image, hyperlink, and table, select .
- To change the text or object preference, select .

4 When you are finished, select .

5 Enter a name for the document and select the location to save the document.

6 Select **Save**.

## › Open a document

- 1 Open the application list and select **Polaris Office**.
- 2 Select **Browser** → a document file.
- 3 View the document as desired.
  - To edit the document (word, presentation, or excel file), tap the screen.
  - To save the document for other name, select  → **Save as**.
  - To search or replace text on the document, select  → **Find & Replace**.
  - To zoom in or out, place two fingers on the screen and slowly spread them apart or pinch them together. You can also select  → **Zoom**.
  - To print the file using a Wi-Fi or USB connection, select  → **Print**. Your device is compatible only with some Samsung printers.
  - To switch to Multi Window mode, select .



Available options may vary depending on a document type.

## › Manage documents online

- 1 Open the application list and select **Polaris Office**.
- 2 Select **Clouds** → an account.
- 3 Enter your email address and password to access your account, and then select **OK**.
- 4 View and manage your documents on the server.

## PS Touch

Experience core Photoshop features, such as layers, selection tools, adjustments, filters and more to create professional looking images from your device.

With PS Touch, you can easily combine multiple images, edit specific elements and apply filter effects, and you can access your content using Adobe Creative Cloud service.

Open the application list and select **PS Touch**.



To use Adobe Creative Cloud service, you need an Adobe ID.

## Voice Search

Learn to search the Internet by voice.



This feature may be unavailable depending on your region or service provider.

- 1 Open the application list and select **Voice Search**.
- 2 Say a keyword into the microphone.
- 3 The device searches for webpages related to the keyword.
- 4 Select a search result.

## S Voice

Learn to use the voice command feature provided by S Voice. You can dial a number, send a message, write a memo, or complete other tasks simply by speaking to your device.



- This feature may be unavailable depending on your region or service provider.
- If your pronunciation is unclear, when speaking in noisy places, or when speaking with offensive or slang words and in dialectal accents, the device may not recognise your commands or may perform unwanted commands.

1 Open the application list and select **S Voice**.

2 Say a keyword into the microphone.  
To say a new command, select .



You can deactivate voice prompts by selecting .

## World Clock

Learn to view the time in another region.

1 Open the application list and select **World Clock**.

2 Select .

3 Enter a city name and select a city from the list.  
You can select a city in the world map view.

4 Select .

5 To add more world clocks, repeat steps 2-4.



To apply the summer time to the clocks, tap and hold a clock and select **DST settings**.

# Settings

## Access the Settings menu

- 1 Open the application list and select **Settings**.
- 2 Select a setting category, and then select an option.

## Wi-Fi

Activate the Wi-Fi feature to connect to a Wi-Fi network and access the Internet or other network devices.

## Bluetooth

Activate the Bluetooth feature to exchange information over short distances.

## Data usage

Keep track of your data usage amount, and customise the settings for the limitation.

- **Data usage cycle:** Change the settings for the limit cycle.

To use more options, select .

- **Auto sync data:** Set the device to synchronise Contacts, S Planner, Email, Internet, and images with social network sites automatically.
- **Mobile hotspots:** Set the device to restrict or warn against large downloads or stop background applications from using the other device's mobile hotspot.

## More settings

Change the settings to control connections with other devices or networks.

### › Flight mode

Activate Flight mode to disable all wireless functions on your device. You can use only non-network features.

### › VPN

Set up and manage virtual private networks (VPNs).

### › Nearby devices

- **File sharing:** Activate media sharing to allow other DLNA certified devices to access media files on your device.
- **Shared contents:** Set to share your contents with other devices.
- **Device name:** Enter a media server name for your device.
- **Allowed devices list:** View the list of devices that can access your device.
- **Not-allowed devices list:** View the list of devices that are blocked from accessing your device.
- **Download to:** Select a memory location for saving downloaded media files.
- **Upload from other devices:** Set to accept uploads from other device.

### › AllShare Cast

Activate the AllShare Cast feature and share your display with others.

### › Kies via Wi-Fi

Connect your device to Samsung Kies via Wi-Fi.

## Blocking mode

Select which notifications will be blocked or set to allow notifications for calls from specified contacts in Blocking mode.

## Sound

Change the settings for various sounds on your device.

- **Volume:** Adjust the volume for various sounds on your device.
- **Vibration intensity:** Adjust the vibration intensity.
- **Default notifications:** Select a ringtone to alert you to events.
- **Touch sounds:** Set the device to sound when you select an application or option.
- **Screen lock sound:** Set the device to sound when you lock or unlock the touch screen.
- **Haptic feedback:** Set the device to vibrate when you select the touch keys or when the device reacts to certain situations.

## Display

Change the settings to control the display and backlight on your device.

- **Wallpaper:** Change the wallpaper settings.
  - **Home screen:** Select a background image for the Home screen.
  - **Lock screen:** Select a background image for the locked screen.
  - **Home and lock screens:** Select a background image for the Home screen and the locked screen.

- **Screen mode:** Select a display mode.
- **Brightness:** Adjust the brightness of the display.
- **Screen timeout:** Select the length of time that the device waits before turning off the display backlight.
- **Smart stay:** Set to prevent the display backlight from turning off while you are looking at the display.
- **Font style:** Change the font type for the display text.
- **Font size:** Change the font size for creating or showing items in applications.
- **Quick launch:** Change the quick launch application on the system bar. The shortcut icon changes to indicate the selected application.

## Storage

View memory information for your device and memory card. You can also format the memory card.



Formatting a memory card will permanently delete all data from the memory location.



The actual available capacity of the internal memory is less than the specified capacity because the operating system and default applications occupy part of the memory.



## Power saving mode

Activate Power saving mode. To change the following settings for Power saving mode, deactivate Power saving mode.

- **CPU power saving:** Set the device to limit some system resource usage.
- **Screen power saving:** Set the device to decrease the brightness of the display.
- **Turn off haptic feedback:** Set to prevent the device from vibrating when you press the Home key or the Back key, or press and hold the Power key.
- **Learn about Power saving mode:** View information for saving battery power.

## Battery

View the amount of battery power consumed by your device.

## Application manager

View and manage the applications on your device.

## Location services

Change the settings for location services.

- **Use wireless networks:** Set to use Wi-Fi and/or mobile networks for finding your location.
- **Use GPS satellites:** Set to use the GPS satellite for finding your location.
- **Location and Google search:** Set the device to use your current location for Google search and other Google services.

## Lock screen

Change the Lock screen mode.

- **Screen lock:** Activate the screen lock feature.
- **Lock screen options:**



The settings are applied only when you set the swipe lock option.

- **Shortcuts:** Set to show and edit application shortcuts on the locked screen.
- **Information ticker:** Set to show news or stock information on the locked screen.
- **Clock:** Set to show the clock on the locked screen.
- **Weather:** Set to show the weather information and change the settings for the weather display.
- **Ripple effect:** Set to show the ripple effect on the locked screen.
- **Help text:** Set to show the help text on the locked screen.
- **Wake up in lock screen:** Set the device to recognise your wake up command when the screen is locked.
- **Set wake-up command:** Set a wake up command to launch the S Voice application or perform a specified function.
- **Popup Note on lock screen:** Set to launch Popup Note by double-tapping the screen when the touch screen is turned off.
- **Owner information:** Enter your information that is shown on the locked screen.

## Security

Change the settings for securing your device and the SIM or USIM card.

- **Encrypt device:** Set a password to encrypt data saved on the device. You must enter the password each time you turn on the device.

 Charge the battery before enabling this setting because it may take more than an hour to encrypt your data.

- **Encrypt external SD card:**

- **Encrypt:** Set to encrypt files when you save them to a memory card.
- **Full encryption:** Set to encrypt all files on your memory card.
- **Exclude multimedia files:** Set to encrypt all files except multimedia files on your memory card.

 You may not access the encrypted memory card after the factory data reset. First, decode the memory card before the factory data reset.

- **Remote controls:** Set to allow remote control of your device via the Internet when your device is lost or stolen.
- **Find my mobile web page:** Access the SamsungDive website ([www.samsungdive.com](http://www.samsungdive.com)). You can track and control your lost or stolen device on the SamsungDive website.
- **Make passwords visible:** Set to show your passwords as you enter them.
- **Device administrators:** View the administrators you have approved for your device. You can allow device administrators to apply new policies to your device.

- **Unknown sources:** Set the device to install applications downloaded from any source. If you do not select this option, you can install only applications downloaded from Play Store.
- **Trusted credentials:** Set to use certificates and credentials to ensure the secure use of applications.
- **Install from device storage:** Install encrypted certificates that are stored in the USB storage.
- **Clear credentials:** Delete credentials from the device and reset the password.

## Language and input

Change the settings for languages and text input.

### › Language

Select a display language.

### › Default

Select a text input method.

### › Google voice typing

Activate the Google voice input feature to enter text by voice. To change the voice input settings, select .

- **Choose input languages:** Select input languages for Google voice recognition.
- **Block offensive words:** Set to prevent the device from recognising offensive words in voice inputs.
- **Download offline speech recognition:** Download and install language data for offline voice input.

## › Samsung keyboard

To change the Samsung keypad settings, select .

- **Input language:** Select input languages to use with the keypad.
- **Predictive text:** Activate XT9 mode to predict words based on your input and show word suggestions.
- **Continuous input:** Set to enter text by sweeping on the keypad.
- **Handwriting:** Change the settings for Handwriting mode, such as recognition time, pen thickness, or pen colour.
- **Voice input:** Activate the voice input feature to enter text by voice.
- **Auto capitalisation:** Set to capitalise the first letter of a sentence automatically.
- **Auto-punctuate:** Set the device to insert a full stop when you double-tap the space bar.
- **Character preview:** Set the device to show a preview image of each letter you tap.
- **Key-tap vibration:** Set the device to vibrate when you tap a key.
- **Key-tap sound:** Set the device to sound when you tap a key.
- **Tutorial:** View the tutorial for using the Samsung keypad.
- **Reset settings:** Reset the Samsung keypad settings to the factory defaults.

## › Voice search

The following options are available for Google voice recognition:

- **Language:** Select a language for Google voice recognition.
- **Speech output:** Set the device to provide voice feedback to alert you to the current action.
- **Block offensive words:** Set to hide offensive words from voice search results.
- **Download offline speech recognition:** Download and install language data for offline voice input.

## › Text-to-speech output

- **Preferred TTS engine:** Select a speech synthesis engine. To change the settings for speech synthesis engines, select .
- **Speech rate:** Select a speed for the TTS feature.
- **Listen to an example:** Listen to the spoken text for an example.
- **Driving mode:** Activate Driving mode to provide audible notifications for event details.

## › Pointer speed

Adjust the pointer speed for the mouse or trackpad connected to your device.

## Cloud

Change settings for syncing data or files with your Samsung account or Dropbox cloud storage.

## Back up and reset

Change the settings for managing settings and data.

- **Back up my data:** Set to back up your settings and application data to the Google server.
- **Backup account:** Set up or edit your Google backup account.
- **Automatic restore:** Set to restore your settings and application data when you must reinstall an application.
- **Factory data reset:** Reset your settings to the factory defaults and delete all your data.

## Add account

Add your email or SNS accounts.

## Motion

Change the settings that control the motion recognition feature on your device.

- **Tilt to zoom:** Set to use a tilting motion to zoom in or out when viewing image in Gallery or browsing webpages.
- **Pan to move icon:** Set to move an item to another page when you tap and hold the item, and then slide the device to the left or right.
- **Pan to browse images:** Set to scroll through an image by sliding the device in any direction when the image is zoomed in.
- **Sensitivity settings:** Adjust the reaction speed for each motion.
- **Learn about motions:** View the tutorial for controlling motions.

## S Pen

Change the settings for using the S Pen.

- **Pen attach/detach sound:** Set the device to emit a sound when the S Pen is inserted or pulled out from the slot.
- **Battery saving:** Set the screen not to respond when inserting or removing the S Pen.
- **Options after detaching pen:** Set to show a pop-up window and emit an alert sound when the S Pen is no longer near the device.
- **Air view:** Set to show the S Pen pointer when the S pen is hovering over the screen.
- **Sound and haptic feedback:** Set the device to emit a sound and vibrate when the Air View feature is activated.
- **Quick Command settings:** Configure the settings for Quick Command.
- **S Pen help:** Access help information for using the S Pen.

## Accessory

- **Dock sound:** Set the device to play a sound when your device is connected to or removed from a desktop dock.
- **Audio output:** Set to use the dock speaker when your device is connected to a desktop dock.



Some devices may not support the surround sound setting.



## Date and time

Change the settings to control how time and date appears on your device.



If the battery remains fully discharged or removed from the device, the time and date will be reset.

- **Set date:** Set the current date manually.
- **Set time:** Set the current time manually.
- **Select time zone:** Select a time zone.
- **Use 24-hour format:** Set to show the time in 24-hour format or 12-hour format.
- **Select date format:** Select a date format.

## Accessibility

Accessibility services are special features for those with physical challenges. Change the settings to improve accessibility to the device's interface and features.

- **Auto-rotate screen:** Set the interface to rotate automatically when you rotate the device.
- **Screen timeout:** Select the length of time that the device waits before turning off the display backlight.
- **Speak passwords:** Set the device to read aloud passwords with TalkBack.
- **Accessibility shortcut:** Add a shortcut to accessibility settings that appears when you press and hold the Power key.

- **TalkBack:** Activate TalkBack, which provides voice feedback.
- **Font size:** Change the font size for creating or showing items in applications.
- **Negative colours:** Reverse the display colours to improve visibility.
- **Text-to-speech output:**
  - **Preferred TTS engine:** Select a speech synthesis engine. To change the settings for speech synthesis engines, select .
  - **Speech rate:** Select a speed for the TTS feature.
  - **Listen to an example:** Listen to the spoken text for an example.
  - **Driving mode:** Activate Driving mode to provide audible notifications for incoming calls, messages, or event details.
- **Enhance web accessibility:** Set applications to install web scripts to make their web content more accessible.
- **Mono audio:** Enable mono sound when you listen to audio with one earbud.
- **Turn off all sounds:** Mute all device sounds.
- **Tap and hold delay:** Set the recognition time for tapping and holding the screen.

## Developer options

Change the settings for application development.

- **Desktop backup password:** Set a password to secure your backup data.
- **Stay awake:** Set the screen to remain on while you are charging the battery.

- **Protect SD card:** Set the device to allow only applications with appropriate permission to access data on the memory card.
- **USB debugging:** Activate USB debugging mode to connect your device to a computer with a USB cable.
- **Allow mock locations:** Allow mock locations and service information to be sent to a Location Manager service for testing.
- **Select debug app:** Select applications to debug and prevent errors when you pause debugging.
- **Wait for debugger:** Set to prevent the selected application from loading until the debugger is ready.
- **Show touches:** Set to show the pointer when you touch the screen.
- **Show pointer location:** Set to show the coordinates and traces of the pointer when you touch the screen.
- **Show layout boundaries:** Set to show boundaries.
- **Show GPU view updates:** Set to flash areas of the screen when they are updated with the GPU.
- **Show screen updates:** Set to flash areas of the screen when they are updated.
- **Window animation scale:** Select a speed for opening and closing pop-up windows.
- **Transition animation scale:** Select a speed for switching between screens.
- **Animator duration scale:** Select how long pop-up windows will be shown.
- **Disable hardware overlays:** Set to hide hardware overlays.

- **Force GPU rendering:** Set to use 2D hardware acceleration to improve graphic performance.
- **Strict mode:** Set the device to flash the screen when applications perform long operations.
- **Show CPU usage:** Set to list all active processes.
- **Profile GPU rendering:** Set to check the time of GPU rendering time.
- **Enable traces:** Set to capture traces of application and system performance.
- **Do not keep activities:** Set to end a running application when you launch a new application.
- **Limit background processes:** Set to limit the number of processes that can run in the background.
- **Show all ANRs:** Set the device to alert you to unresponsive applications that are running in the background.

## About device

View information about your device, such as model number and version.



You can download and install firmware update with the firmware over-the-air (FOTA) service. To check for firmware updates, select **Software update** → **Update**.

# Troubleshooting

## Your device displays network or service error messages

- When you are in areas with weak signals or poor reception, you may lose reception. Move to another area and try again.
- You cannot access some options without a subscription. Contact your service provider for more details.

## The touch screen responds slowly or improperly

If your device has a touch screen and the touch screen is not responding properly, try the following:

- Remove any protective covers from the touch screen. Protective covers may prevent the device from recognising your inputs and are not recommended for touch screen devices.
- Ensure that your hands are clean and dry when tapping the touch screen.
- Restart your device to clear any temporary software bugs.
- Ensure that your device's software is upgraded to the latest version.
- If the touch screen is scratched or damaged, take your device to a Samsung Service Centre.

## Your device freezes or has fatal errors

If your device freezes or hangs, you may need to close applications or reset the device to regain functionality. If your device is still responsive and an application is frozen, close the application with the task manager. If your device is frozen and unresponsive, press and hold the Power key for 8-10 seconds. If this problem persists, perform a factory data reset. In the application list, select **Settings** → **Back up and reset** → **Factory data reset** → **Reset device** → **Erase everything**.

## The device beeps and the battery icon is empty

Your battery is low. Recharge the battery to continue using the device.

## The battery does not charge properly or the device turns off

If the battery will no longer charge completely, you need to replace it with a new battery. Take your device to your local Samsung Service Centre.

## Your device is hot if touched

When you use applications that require more power or use applications on your device for an extended period of time, your device may feel hot. This is normal and should not affect your device's lifespan or performance.

## **Error messages appear when launching the camera**

Your device must have sufficient memory and battery power available to operate the camera application. If you receive error messages when launching the camera, try the following:

- Charge the battery.
- Free some memory by transferring files to a computer or deleting files from your device.
- Restart the device. If you are still having trouble with the camera application after trying these tips, contact a Samsung Service Centre.

## **Error messages appear when opening music files**

Some music files may not play on your device for a number of reasons. If you receive error messages when opening music files on your device, try the following:

- Free some memory by transferring files to a computer or deleting files from your device.
- Ensure that the music file is not Digital Rights Management (DRM)-protected. If the file is DRM-protected, ensure that you have the appropriate licence or key to play the file.
- Ensure that your device supports the file type.

## **Another Bluetooth device is not located**

- Ensure that the Bluetooth feature is activated on your device.
- Ensure that the Bluetooth feature is activated on the device you wish to connect to, if necessary.
- Ensure that your device and the other Bluetooth device are within the maximum Bluetooth range (10 m).

If the tips above do not solve the problem, contact a Samsung Service Centre.

## A connection is not established when you connect the device to a computer

- Ensure that the USB cable you are using is compatible with your device.
- Ensure that you have the proper drivers installed and updated on your computer.
- If you are a Windows XP user, ensure that you have Windows XP Service Pack 3 or higher installed on your computer.
- Ensure that you have Samsung Kies 2.0 or Windows Media Player 10 or higher installed on your computer.



# Index

## alarms

- creating 128
- deactivating 128
- stopping 128

AllShare Cast 116

AllShare Play 117

## battery

- charging 13

## Bluetooth

- activating 122
- finding and pairing with devices 122
- receiving data 123
- sending data 122

calculator 129

## camera

- capturing photos 87
- customising camcorder 94
- customising camera 89, 90
- recording videos 92

## connectivity

- AllShare Play 117
- Bluetooth 121
- PC 110
- VPN connections 126
- Wi-Fi 112

## contacts

- creating 107
- finding 107
- importing or exporting 108

## device

- customising 32
- indicator icons 21
- keys 21
- layout 19
- notifications panel 30
- settings 137
- turning on or off 18

display language 144

download manager 129

## email

- sending 78
- setting accounts 78
- viewing 79

## file manager

- copying or cutting files 132
- deleting files 132
- opening files 131
- supported file formats 131

flight mode 18

Google 74

Google Mail 76

Google Maps 69

Google Now 75

Google Talk 80

Group Cast 120

Learning Hub 75

Local 72

- map
  - getting directions 71
  - searching for locations 70
  - searching for nearby places 72
  - sharing locations with friends 71
  - using navigation 72
- memory card
  - formatting 17
  - inserting 15
  - removing 16
- menu screen
  - accessing 31
- messages
  - sending email 78
  - setting email accounts 78
- music hub 86
- music player
  - creating playlists 85
  - playing music 84
- navigation 72
- PC connections
  - mass storage 111
  - Samsung Kies 110
  - Windows Media Player 111
- phonebook
  - creating contacts 107
- photos
  - capturing 87
  - viewing 99
- Play Books 67
- Polaris Office 133
- Quick Command
  - changing gesture 60
  - creating gesture 60
- Samsung Apps 73
- Samsung Kies 110
- silent mode 33
- S Note 48
- S Pen 40
- S Planner 57
- S Suggest 74
- text input 38
- time and date, set 32
- touch screen
  - locking 24
  - using 23
- unpack 12
- Video Editor 103
- video player 102
- videos
  - playing 95, 102
  - recording 92
- VPN connections
  - connecting to 127
  - creating 126
- web browser
  - adding bookmarks 65
  - browsing web pages 62

## Wi-Fi

- activating 112
- finding and connecting to networks 112
- using WPS 113

## world clock 136

## YouTube

- uploading videos 69
- watching videos 68

Some of the contents in this manual may differ from your device depending on the software of the device or your service provider.

### **To install Kies (PC Sync) Kies**

1. Download the latest version of Kies from the Samsung website ([www.samsung.com/kies](http://www.samsung.com/kies)) and install it on your PC.
2. Using a USB cable, connect your device to your PC. Samsung Kies will launch automatically. Refer to the Kies help for more information.